

# JVC

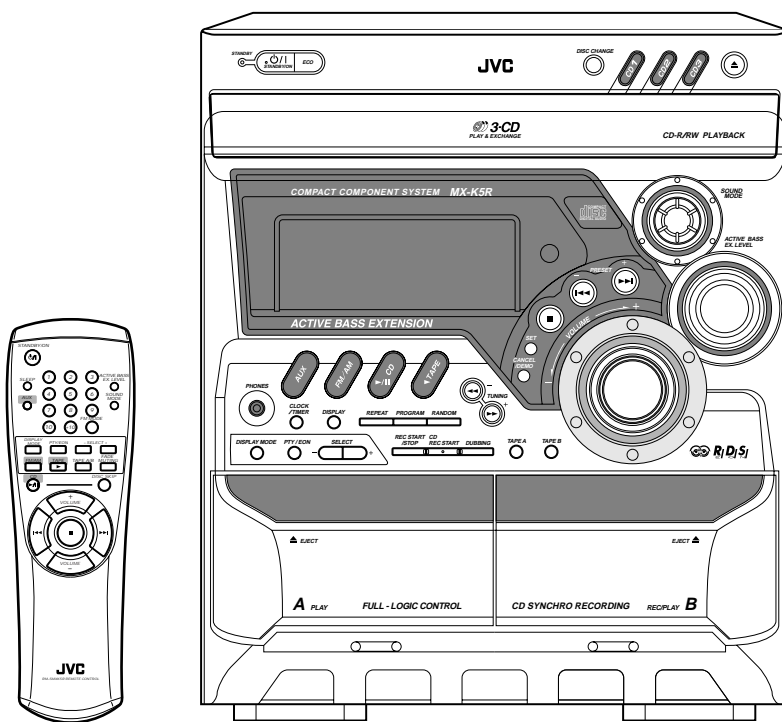

## COMPACT COMPONENT SYSTEM

# CA-MXK5R



## INSTRUCTIONS

### For Customer Use:

Enter below the Model No. and Serial No. which are located either on the rear, bottom or side of the cabinet. Retain this information for future reference.

Model No. \_\_\_\_\_

Serial No. \_\_\_\_\_

LVT0689-009B

[B]

## Warnings, Cautions and Others

### IMPORTANT for the U.K.

**DO NOT** cut off the mains plug from this equipment. If the plug fitted is not suitable for the power points in your home or the cable is too short to reach a power point, then obtain an appropriate safety approved extension lead or consult your dealer.

**BE SURE** to replace the fuse only with an identical approved type, as originally fitted.

If nonetheless the mains plug is cut off ensure to remove the fuse and dispose of the plug immediately, to avoid a possible shock hazard by inadvertent connection to the mains supply.

If this product is not supplied fitted with a mains plug then follow the instructions given below:

### IMPORTANT:

**DO NOT** make any connection to the terminal which is marked with the letter E or by the safety earth symbol or coloured green or green-and-yellow.

The wires in the mains lead on this product are coloured in accordance with the following code:

Blue : Neutral  
Brown : Live

As these colours may not correspond with the coloured markings identifying the terminals in your plug proceed as follows:

The wire which is coloured blue must be connected to the terminal which is marked with the letter N or coloured black.

The wire which is coloured brown must be connected to the terminal which is marked with the letter L or coloured red.

**IF IN DOUBT - CONSULT A COMPETENT ELECTRICIAN.**

### Caution — STANDBY/ON switch!

Disconnect the mains plug to shut the power off completely. The  STANDBY/ON switch in any position does not disconnect the mains line. The power can be remote controlled.

### CAUTION

To reduce the risk of electrical shocks, fire, etc.:

1. Do not remove screws, covers or cabinet.
2. Do not expose this appliance to rain or moisture.

## IMPORTANT FOR LASER PRODUCTS

### REPRODUCTION OF LABELS

- ① CLASSIFICATION LABEL, PLACED ON REAR ENCLOSURE



- ② WARNING LABEL, PLACED INSIDE THE UNIT

**CAUTION:** Invisible laser radiation when open and interlock failed or defeated. AVOID DIRECT EXPOSURE TO BEAM. (e)

**WARNING:** Osynlig laserstrålning när denna del är öppnad och spärren är urkopplad. Betrakta ej strålen. (s)

**ADVARSEL:** Usynlig laserstrålning ved åbning, når sikkerhedsbrydere er ude af funktion. Undgå udsættelse for stråling. (d)

**VARO:** Avattaessa ja suojalukitus ohitettaessa olet alttiina näkymättömälle lasersäteilylle. Älä katso säteeseen. (f)

1. CLASS 1 LASER PRODUCT
2. **CAUTION:** Invisible laser radiation when open and interlock failed or defeated. Avoid direct exposure to beam.
3. **CAUTION:** Do not open the top cover. There are no user serviceable parts inside the Unit; leave all servicing to qualified service personnel.

### CAUTION

- Do not block the ventilation openings or holes. (If the ventilation openings or holes are blocked by a newspaper or cloth, etc., the heat may not be able to get out.)
- Do not place any naked flame sources, such as lighted candles, on the apparatus.
- When discarding batteries, environmental problems must be considered and local rules or laws governing the disposal of these batteries must be followed strictly.
- Do not use this apparatus in a bathroom or places with water. Also do not place any containers filled with water or liquids (such as cosmetics or medicines, flower vases, potted plants, cups, etc.) on top of this apparatus.

### Caution: Proper Ventilation

To avoid risk of electric shock and fire, and to prevent damage, locate the apparatus as follows:

#### 1 Front:

No obstructions and open spacing.

#### 2 Sides/ Top/ Back:

No obstructions should be placed in the areas shown by the dimensions below.

#### 3 Bottom:

Place on the level surface. Maintain an adequate air path for ventilation by placing on a stand with a height of 10 cm or more.

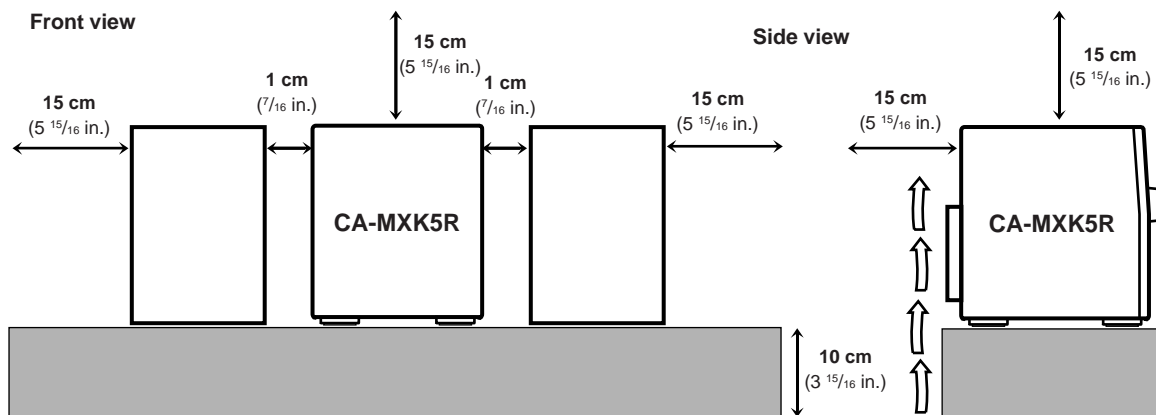

## **SAFETY INSTRUCTIONS**

### **“SOME DOS AND DON'TS ON THE SAFE USE OF EQUIPMENT”**

This equipment has been designed and manufactured to meet international safety standards but, like any electrical equipment, care must be taken if you are to obtain the best results and safety is to be assured.

\*\*\*\*\*

Do read the operating instructions before you attempt to use the equipment.

Do ensure that all electrical connections (including the mains plug, extension leads and interconnections between pieces of equipment) are properly made and in accordance with the manufacturer's instructions. Switch off and withdraw the mains plug when making or changing connections.

Do consult your dealer if you are ever in doubt about the installation, operation or safety of your equipment.

Do be careful with glass panels or doors on equipment.

\*\*\*\*\*

DON'T continue to operate the equipment if you are in any doubt about it working normally, or if it is damaged in any way—switch off, withdraw the mains plug and consult your dealer.

DON'T remove any fixed cover as this may expose dangerous voltages.

DON'T leave equipment switched on when it is unattended unless it is specifically stated that it is designed for unattended operation or has a standby mode.

Switch off using the switch on the equipment and make sure that your family know how to do this.

Special arrangements may need to be made for infirm or handicapped people.

DON'T use equipment such as personal stereos or radios so that you are distracted from the requirements of traffic safety. It is illegal to watch television whilst driving.

DON'T listen to headphones at high volume as such use can permanently damage your hearing.

DON'T obstruct the ventilation of the equipment, for example with curtains or soft furnishings.

Overheating will cause damage and shorten the life of the equipment.

DON'T use makeshift stands and NEVER fix legs with wood screws — to ensure complete safety always fit the manufacturer's approved stand or legs with the fixings provided according to the instructions.

DON'T allow electrical equipment to be exposed to rain or moisture.

ABOVE ALL

- NEVER let anyone, especially children, push anything into holes, slots or any other opening in the case -this could result in a fatal electrical shock.;
- NEVER guess or take chances with electrical equipment of any kind
- it is better to be safe than sorry!

# Introduction

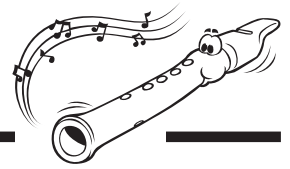

We would like to thank you for purchasing one of our JVC products. Before operating this unit, read this manual carefully and thoroughly to obtain the best possible performance from your unit, and retain this manual for future reference.

## About This Manual

This manual is organized as follows:

- The manual mainly explains operations using the buttons and controls on the unit. You can also use the buttons on the remote control if they have the same or similar names (or marks) as those on the unit. If operation using the remote control is different from that using the unit, it is then explained.
- Basic and common information that is the same for many functions is grouped in one place, and is not repeated in each procedure. For instance, we do not repeat the information about turning on/off the unit, setting the volume, changing the sound effects, and others, which are explained in the section “Common Operations” on pages 9 and 10.
- The following marks are used in this manual:



Gives you warnings and cautions to prevent damage or risk of fire/electric shock. Also gives you information which is not good for obtaining the best possible performance from the unit.



Gives you information and hints you had better know.

## Precautions

### Installation

- Install in a place which is level, dry and neither too hot nor too cold — between 5°C (41°F) and 35°C (95°F).
- Install the unit in a location with adequate ventilation to prevent internal heat built-up in the unit.
- Leave sufficient distance between the unit and the TV.
- Keep the speakers away from the TV to avoid interference with TV.



DO NOT install the unit in a location near heat sources, or in a place subject to direct sunlight, excessive dust or vibration.

### Power sources

- When unplugging from the wall outlet, always pull the plug, not the AC power cord.



DO NOT handle the AC power cord with wet hands.

### Moisture condensation

Moisture may condense on the lens inside the unit in the following cases:

- After starting heating in the room
  - In a damp room
  - If the unit is brought directly from a cold to a warm place
- Should this occur, the unit may malfunction. In this case, leave the unit turned on for a few hours until the moisture evaporates, unplug the AC power cord, and then plug it in again.

### Others

- Should any metallic object or liquid fall into the unit, unplug the unit and consult your dealer before operating any further.
- If you are not going to operate the unit for an extended period of time, unplug the AC power cord from the wall outlet.



DO NOT disassemble the unit since there are no user serviceable parts inside.

If anything goes wrong, unplug the AC power cord and consult your dealer.

# Contents

---

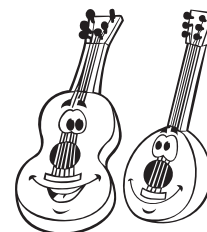

<b>Location of the Buttons and Controls .....</b>	<b>3</b>	<b>Playing Back CDs .....</b>	<b>14</b>
Front Panel .....	3	Loading CDs .....	14
Remote Control .....	5	Playing Back the Entire Discs	
<b>Getting Started .....</b>	<b>6</b>	— Continuous Play .....	14
Unpacking .....	6	Basic CD Operations .....	15
Putting the Batteries into the Remote Control .....	6	Programming the Playing Order of the Tracks	
Connecting Antennas .....	6	— Program Play .....	15
Connecting Speakers .....	7	Playing at Random — Random Play .....	16
Connecting Other Equipment .....	8	Repeating Tracks or CDs — Repeat Play .....	16
Cancelling the Display Demonstration .....	8	Prohibiting Disc Ejection — Tray Lock .....	16
<b>Common Operations .....</b>	<b>9</b>	<b>Playing Back Tapes .....</b>	<b>17</b>
Turning On or Off the Power .....	9	Playing Back a Tape .....	17
Saving the Power Consumption While on Standby		<b>Recording .....</b>	<b>18</b>
— ECO-mode .....	9	Recording a Tape on Deck B .....	18
Setting the Clock .....	9	Dubbing Tapes .....	19
Selecting the Sources .....	9	CD Synchronized Recording .....	19
Adjusting the Volume .....	10	<b>Using the Timers .....</b>	<b>20</b>
Reinforcing the Bass Sound .....	10	Using Daily Timer .....	20
Selecting the Sound Modes .....	10	Using Recording Timer .....	21
<b>Listening to FM, MW, and LW Broadcasts .....</b>	<b>11</b>	Using Sleep Timer .....	22
Tuning in a Station .....	11	Timer Priority .....	22
Presetting Stations .....	11	<b>Maintenance .....</b>	<b>23</b>
Tuning in a Preset Station .....	11	<b>Troubleshooting .....</b>	<b>24</b>
<b>Receiving FM Stations with RDS .....</b>	<b>12</b>	<b>Additional Information .....</b>	<b>25</b>
Changing the RDS Information .....	12	<b>Specifications .....</b>	<b>26</b>
Searching for Programs by PTY Codes			
(PTY Search) .....	12		
Switching to a Traffic Announcement Temporarily .	13		

# Location of the Buttons and Controls

Become familiar with the buttons and controls on your unit.

## Front Panel

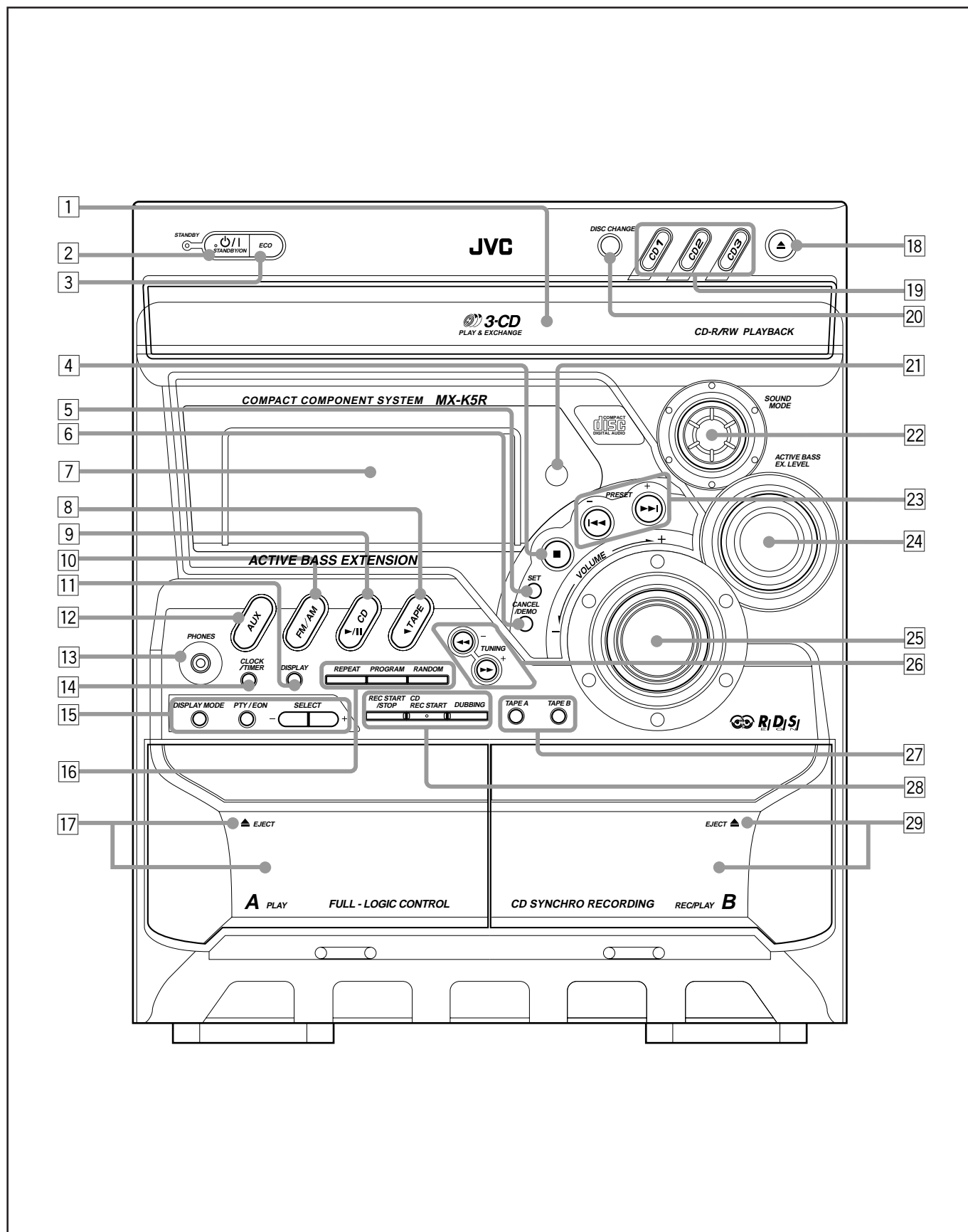

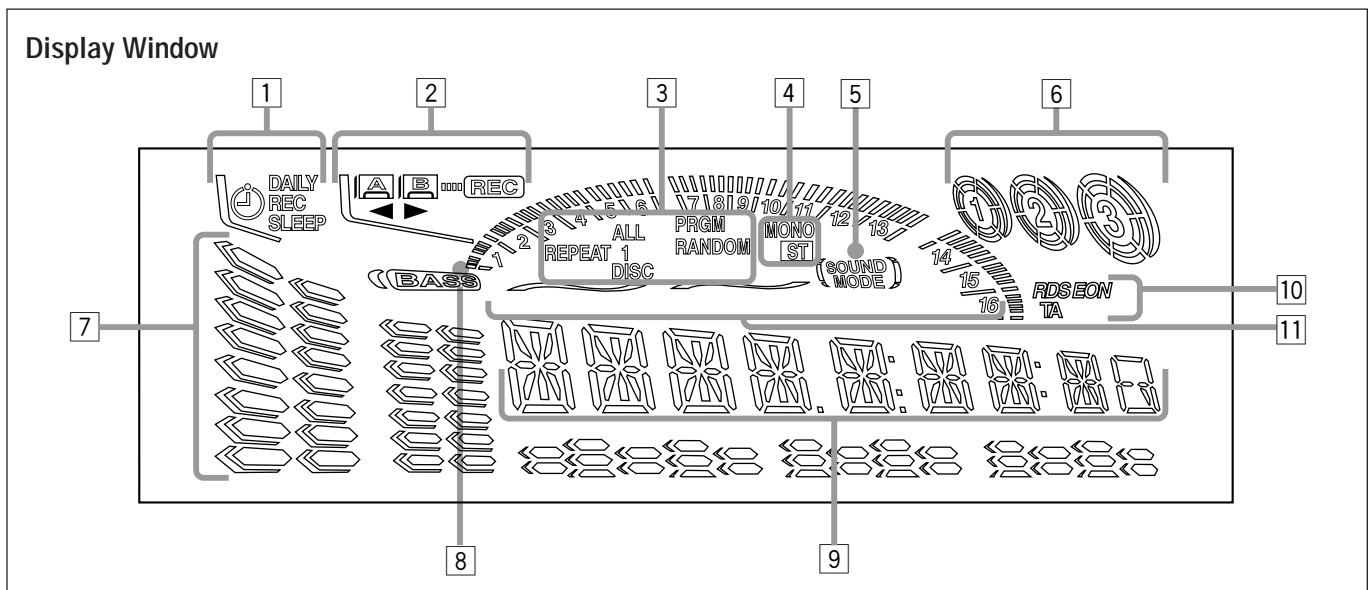

See pages in the parentheses for details.

### Front Panel

- 1 Carrousel
- 2 **⏻/⏻** STANDBY/ON button and STANDBY lamp (9)
- 3 ECO button (9)
- 4 **■** (stop) button (14 – 19)
- 5 SET button (9, 11, 15, 20 – 22)
- 6 CANCEL button (9, 16, 21, 22)  
DEMO button (8)
- 7 Display window
- 8 TAPE **▶** button and lamp (9, 17, 19)  
*Pressing this button also turns on the unit.*
- 9 CD **▶/⏻** (play/pause) button and lamp (9, 14 – 16)  
*Pressing this button also turns on the unit.*
- 10 FM/AM button and lamp (9, 11)  
*Pressing this button also turns on the unit.*
- 11 DISPLAY button (9)
- 12 AUX button and lamp (9)  
*Pressing this button also turns on the unit.*
- 13 PHONES jack (10)
- 14 CLOCK/TIMER button (9, 20 – 22)
- 15 RDS operation buttons (12)  
• DISPLAY MODE, PTY/EON, and SELECT + / –
- 16 REPEAT button (16)  
PROGRAM button (15)  
RANDOM button (16)
- 17 Deck A cassette holder (17, 19)  
• Pressing the **▲** EJECT portion opens the holder.
- 18 **▲** (Carrousel open/close) button (14 – 16)  
*Pressing this button also turns on the unit.*
- 19 Disc number buttons and lamps (CD1, CD2, and CD3)  
(14, 15, 19)  
*Pressing one of these buttons also turns on the unit.*
- 20 DISC CHANGE button (14, 15)
- 21 Remote sensor
- 22 SOUND MODE control (10)

- 23 PRESET + / – buttons (11)  
**◀◀ / ▶▶** (reverse search/forward search) buttons  
(9, 15, 20 – 22)
- 24 ACTIVE BASS EX. LEVEL control (10)
- 25 VOLUME control (10)
- 26 TUNING + / – buttons (11)  
**◀◀ / ▶▶** (fast rewind/fast forward) buttons (15, 17)
- 27 TAPE A button (17)  
TAPE B button (17)
- 28 REC START/STOP button (18)  
CD REC START button (19)  
DUBBING button (19)
- 29 Deck B cassette holder (17 – 19)  
• Pressing the EJECT **▲** portion opens the holder.

### Display window

- 1 Timer indicators  
• DAILY (daily timer), REC (recording timer), SLEEP (sleep timer), and **⌚** (timer) indicators
- 2 Tape operation indicators  
• A/B (operating deck), REC (recording), and **◀▶** (tape running) indicators
- 3 CD play mode indicators  
• REPEAT (1, 1 DISC, ALL DISC), PRGM (program), and RANDOM indicators
- 4 Tuner operation indicators  
• MONO and ST (stereo) indicators
- 5 SOUND MODE indicator
- 6 Disc indicators
- 7 Volume level, Bass level, and Sound Mode pattern indicators
- 8 BASS and its level indicators
- 9 Main display  
• Shows the source name, frequency, etc.
- 10 RDS operation indicators  
• RDS, EON, and TA indicators
- 11 CD track number indicators



## Remote Control

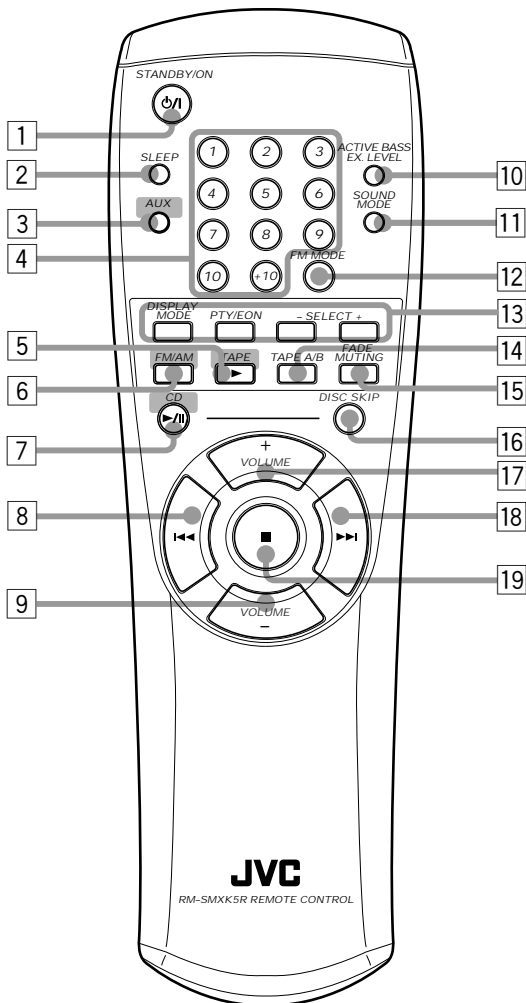

## Remote Control

- 1 STANDBY/ON button (9)
- 2 SLEEP button (22)
- 3 AUX button (9)  
*Pressing this button also turns on the unit.*
- 4 Number buttons (11, 15)
- 5 TAPE button (9, 17)  
*Pressing this button also turns on the unit.*
- 6 FM/AM button (9, 11)  
*Pressing this button also turns on the unit.*
- 7 CD button (9, 14 – 16)  
*Pressing this button also turns on the unit.*
- 8 (fast rewind/reverse search) button (11, 15, 17)
- 9 VOLUME – button (10)
- 10 ACTIVE BASS EX. LEVEL button (10)
- 11 SOUND MODE button (10)
- 12 FM MODE button (11)
- 13 RDS operation buttons (12)  
• DISPLAY MODE, PTY/EON, and SELECT + / –
- 14 TAPE A/B button (17)
- 15 FADE MUTING button (10)
- 16 DISC SKIP button (14)
- 17 VOLUME + button (10)
- 18 (fast forward/forward search) button (11, 15, 17)
- 19 (stop) button (14 – 19)

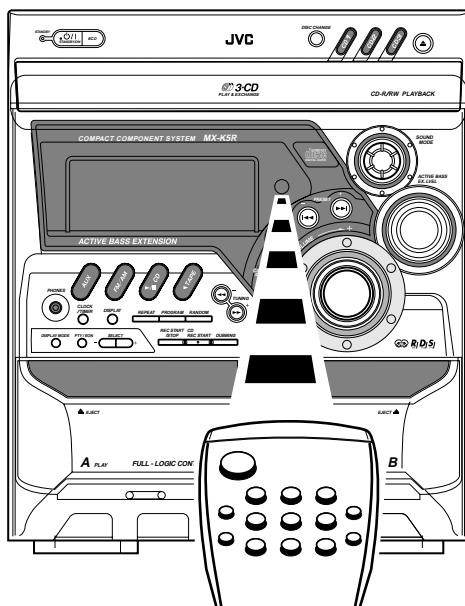

When using the remote control, point it at the remote sensor on the front panel.



## Unpacking

After unpacking, check to be sure that you have all the following items.  
The number in the parentheses indicates the quantity of the pieces supplied.

- AM (MW/LW) loop antenna (1)
- FM antenna (1)
- Remote control (1)
- Batteries (2)

If any is missing, consult your dealer immediately.

## Putting the Batteries into the Remote Control

Insert the batteries — UM-4/AAA/IEC R03 — into the remote control, by matching the polarity (+ and –) on the batteries with the + and – markings on the battery compartment.  
When the remote control can no longer operate the unit, replace both batteries at the same time.

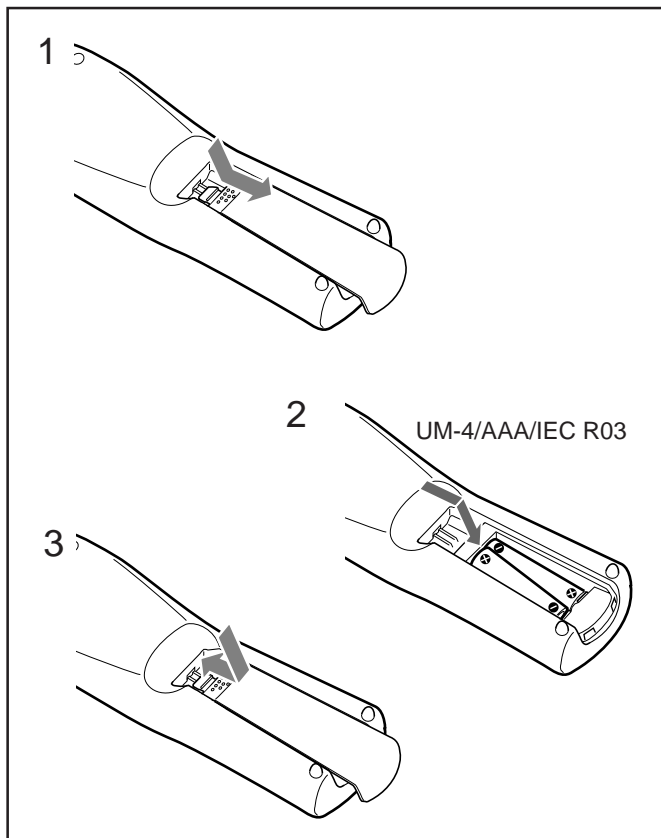

- DO NOT use an old battery together with a new one.
- DO NOT use different types of batteries together.
- DO NOT expose batteries to heat or flame.
- DO NOT leave the batteries in the battery compartment when you are not going to use the remote control for an extended period of time. Otherwise, it will be damaged from battery leakage.

## Connecting Antennas

### FM antenna

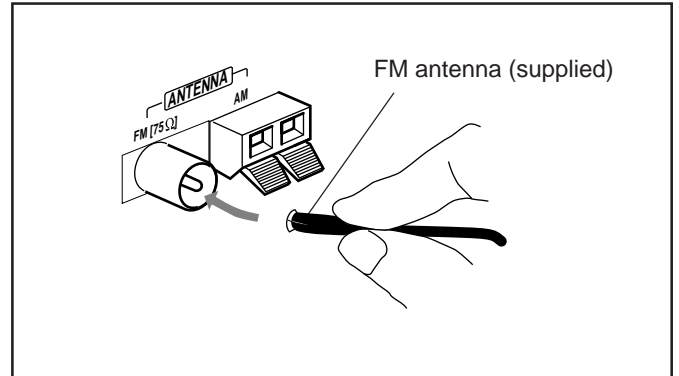

- 1 **Attach the FM antenna to the FM [75 Ω] coaxial terminal.**
- 2 **Extend the FM antenna.**
- 3 **Fasten it up in the position which gives you the best reception, then fix it on the wall, etc.**



#### About the supplied FM antenna

The FM antenna supplied with this unit can be used as temporary measure. If reception is poor, you can connect an outdoor FM antenna.

#### To connect an outdoor FM antenna

Before connecting it, disconnect the supplied FM antenna.

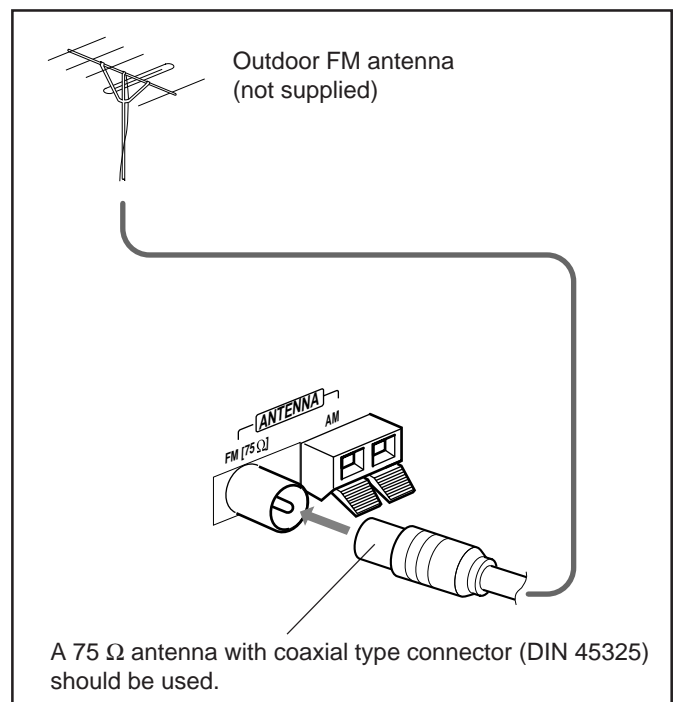

## AM antenna

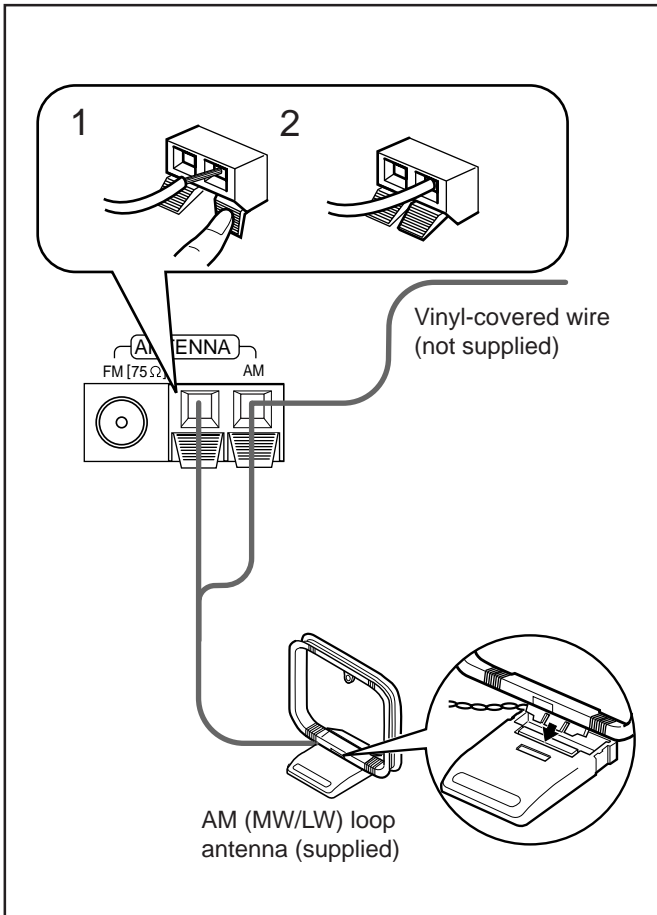

- 1 Press and hold the clamp of the AM terminal on the rear of the unit.
- 2 Insert the end of the AM (MW/LW) loop antenna cord into the terminal.
- 3 Release the finger from the clamp.
- 4 Turn the AM (MW/LW) loop antenna until you have the best reception.

### To connect an outdoor AM (MW/LW) antenna

When reception is poor, connect a single vinyl-covered wire to the AM terminal and extend it horizontally. (The AM (MW/LW) loop antenna must remain connected.)



### For better reception of both FM, MW, and LW

- Make sure the antenna conductors do not touch any other terminals and connecting cords.
- Keep the antennas away from metallic parts of the unit, connecting cords, and the AC power cord.

## Connecting Speakers

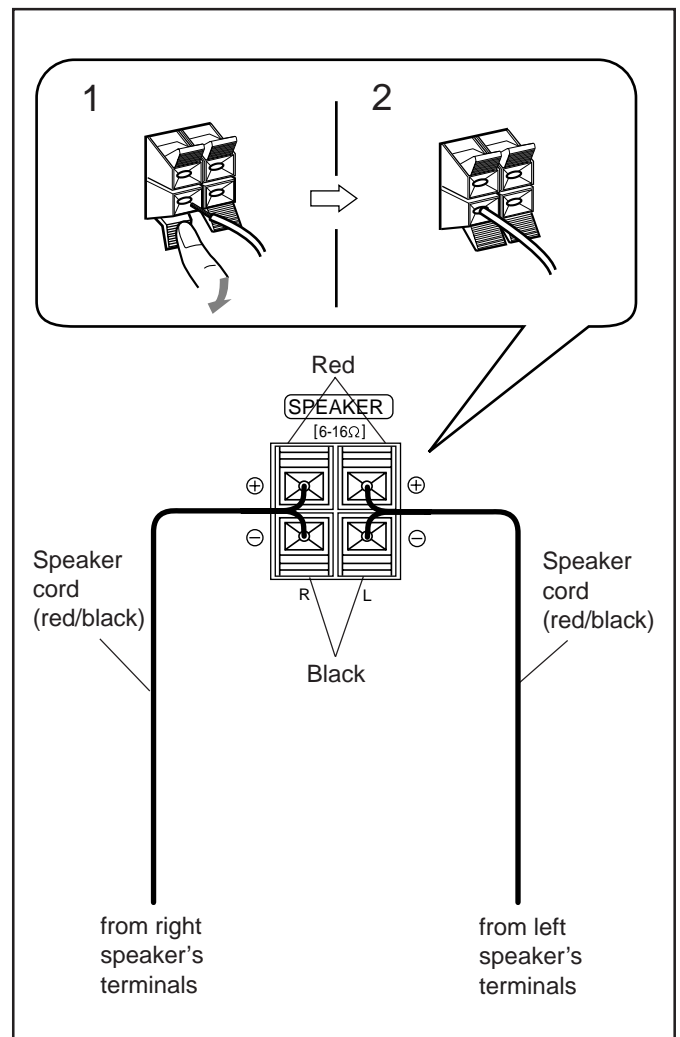

- 1 Press and hold the clamp of the speaker terminal on the rear of the unit.
- 2 Insert the end of the speaker cord into the terminal.  
Match the polarity (colors); Red (+) to red (+) and black (-) to black (-).
- 3 Release the finger from the clamp.

**IMPORTANT:** Use only speakers with the same speaker impedance as indicated by the speaker terminals on the rear of the unit.



## Connecting Other Equipment

You can connect both analog and digital equipment.



- DO NOT connect any equipment while the power is on.
- DO NOT plug in any equipment until all connections are complete.

### To connect an analog component

Be sure that the plugs of the audio cords are color coded: White plugs and jacks are for left audio signals, and red ones for right audio signals.

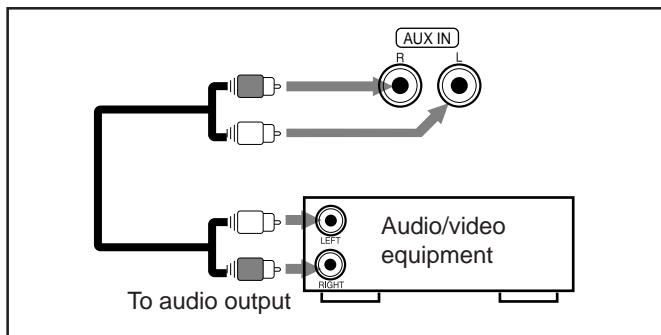

For playing the other equipment through this unit, connect between the audio output jacks on the other equipment and AUX IN jacks by using audio cords (not supplied).

### To connect audio equipment with an optical digital input terminal

You can record CD sound onto the connected digital equipment.

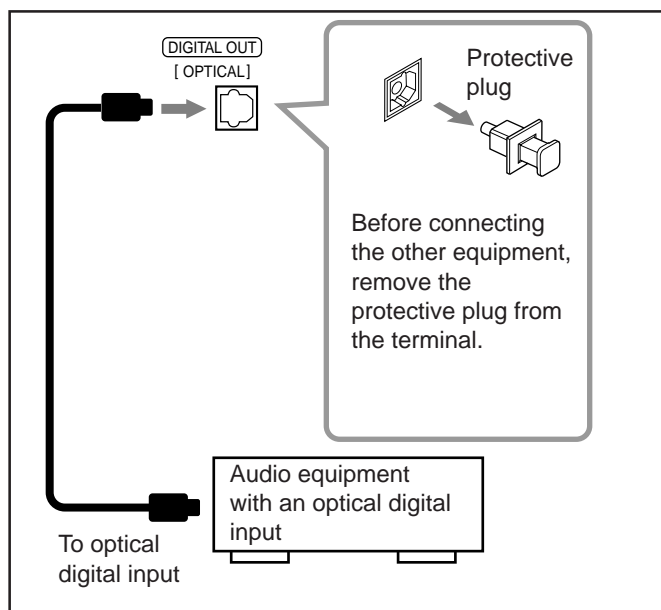

Connect an optical digital cord (not supplied) between the optical digital input terminal on the other equipment and the DIGITAL OUT [OPTICAL] terminal.

**NOW, you can plug in the unit and other connected equipment FINALLY!**

## Canceling the Display Demonstration

When connecting the AC power cord into a wall outlet, the unit automatically starts display demonstration.

### On the unit ONLY:

To cancel the display demonstration, press DEMO.

CANCEL  
/ DEMO



### When you press other buttons

The display demonstration stops temporarily. It will start automatically again (if no operation is done for 2 minutes) until you cancel it by pressing DEMO.

### To start the display demonstration manually

Press and hold DEMO again for more than 2 seconds.

CANCEL  
/ DEMO



# Common Operations

## Turning On or Off the Power

To turn on the unit, press  STANDBY/ON so that the STANDBY lamp goes off.

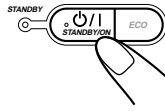

WELCOME

To turn off the unit (on standby), press  STANDBY/ON again so that the STANDBY lamp lights up.

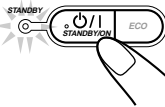

GOOD BYE

A little power is always consumed even while the unit is on standby.

To switch off the power supply completely, unplug the AC power cord from the AC outlet.



**When you unplug the AC power cord or if a power failure occurs**

The clock is reset to “--:--” soon, while the tuner preset stations (see page 11) will be erased in a few days.

## Saving the Power Consumption While on Standby — ECO-mode

You can save the power consumption only while the unit is turned off (on standby).

To activate the ECO-mode, press ECO while the unit is turned off (on standby). The display illumination (including the display demonstration) disappears.

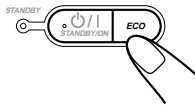

To deactivate the ECO-mode, press ECO again. The display illumination appears.



**About ECO-mode**

While ECO-mode is activated, the display demonstration is canceled temporarily.

## Setting the Clock

Before operating the unit any further, first set the clock built in this unit. You can set the clock whether the unit is on or off.

**On the unit ONLY:**

**1 Press CLOCK/TIMER.**

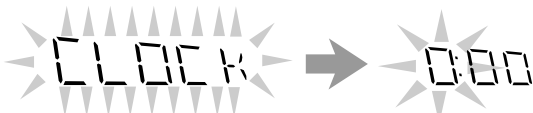

The hour digits start flashing on the display.

**2 Press  or  to adjust the hour, then press SET.**



- If you want to correct the hour after pressing SET, press CANCEL. The hour digits start flashing again.

**3 Press  or  to adjust the minute, then press SET.**

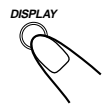
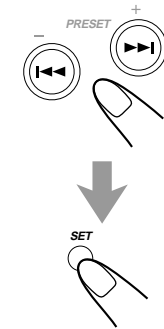
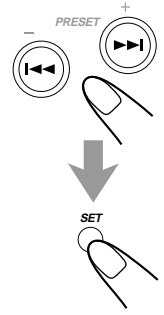

**To check the clock time**

Press DISPLAY while playing any source.

- Each time you press the button, the source indication and the clock time alternate on the display.

**To adjust the clock again**

If you have adjusted the clock before, you need to press CLOCK/TIMER repeatedly until “CLOCK” is selected.

- Each time you press the button, the clock/timer setting modes change as follows:

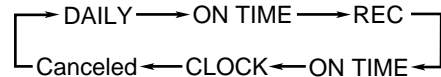

**If there is a power failure**

The clock loses the setting and is reset to “--:--.” You need to set the clock again.

## Selecting the Sources



To listen to the FM, MW, and LW broadcasts, press FM/AM. (See page 11.)

To play back CDs, press CD . (See pages 14 – 16.)

To play back tapes, press TAPE . (See page 17.)

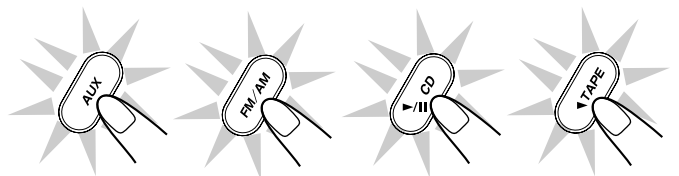
To select the external equipment as the source, press AUX.



When you press the play button for a particular source (AUX, FM/AM, CD , and TAPE ), the unit turns on (and the unit starts playing the source if it is ready — COMPU PLAY CONTROL).

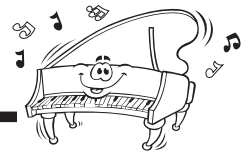

## Adjusting the Volume

You can adjust the volume level only while the unit is turned on.

Turn the **VOLUME** control clockwise to increase the volume or counterclockwise to decrease it.

- The volume level can be adjusted in 32 steps (VOL MIN, VOL 1 — VOL 30, and VOL MAX).

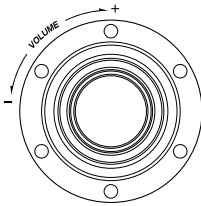

VOL 15

When using the remote control, press **VOLUME +** to increase the volume or press **VOLUME -** to decrease it.



### For private listening

Connect a pair of headphones to the **PHONES** jack. No sound comes out of the speakers. Be sure to turn down the volume before connecting or putting on headphones.



DO NOT turn off (on standby) the unit with the volume set to an extremely high level; otherwise, a sudden blast of sound can damage your hearing, speakers and/or headphones when you turn on the unit or start playing any source next time. REMEMBER you cannot adjust the volume level while the unit is on standby.

### To turn down the volume level temporarily

Press **FADE MUTING** on the remote control. The volume level gradually decreases to “VOL MIN.”



To restore the sound, press the button again.

## Reinforcing the Bass Sound

This function only affects the playback sound, but does not affect your recording.

The **ACTIVE BASS EX. (extension) LEVEL** control provided for this unit can maintain the richness and fullness of the bass sound while listening to any source at low volume.

Turn the **ACTIVE BASS EX. LEVEL** control clockwise to increase the bass sound or counterclockwise to decrease it.

- The bass sound level can be adjusted in 3 steps (LOW, MID, HIGH).

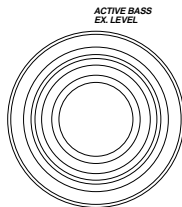

BASS indicator lights up when the Active Bass Extension is turned on.

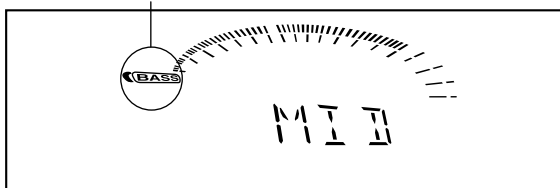

When using the remote control, press **ACTIVE BASS EX. LEVEL** to adjust the bass sound level. The Active Bass Extension level changes as **LOW → MID → HIGH → OFF →** (back to the beginning).

To cancel the **Active Bass Extension**, turn the control counterclockwise until “OFF” appears.

## Selecting the Sound Modes

This function only affects the playback sound, but does not affect your recording.

You can select one of the 6 preset sound modes (3 surround modes and 3 SEA — Sound Effect Amplifier — modes).

To select the sound modes, turn the **SOUND MODE** control until the sound mode you want appears on the display.

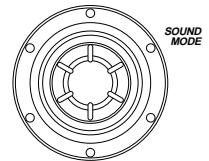

**SOUND MODE** indicator also lights up on the display.



- As you turn the control, the sound modes change as follows:

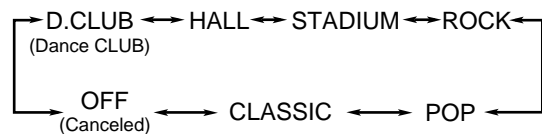

### Surround modes\*:

- D.CLUB:** Increases resonance and bass.
- HALL:** Adds depth and brilliance to the sound.
- STADIUM:** Adds clarity and spreads the sound, like in an outdoor stadium.

### SEA (Sound Effect Amplifier) modes:

- ROCK:** Boosts low and high frequency. Good for acoustic music.
- POP:** Good for vocal music.
- CLASSIC:** Good for classical music.
- OFF:** Cancels the sound mode.

\* Surround elements are added to the SEA elements to create a being-there feeling in your room.

When one of these modes is selected, the **SOUND MODE** indicator lights up as — **(SOUND MODE)**

While one of the SEA modes (SEA elements without surround elements) is selected, the **SOUND MODE** indicator lights up as — **SOUND MODE**

When using the remote control, press **SOUND MODE** to adjust the sound mode.

- Each time you press the button, the sound modes change as follows:

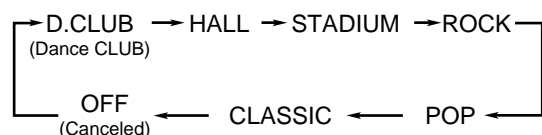

# Listening to FM, MW, and LW Broadcasts



## Tuning in a Station

### 1 Press FM/AM.

The unit automatically turns on and tunes in the previously tuned station (FM, MW or LW).

- Each time you press the button, the band changes among FM, MW, and LW.

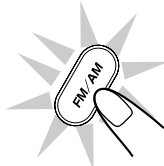

### 2 Start searching for stations.

#### On the unit:

Press and hold TUNING + or TUNING – for more than 1 second.

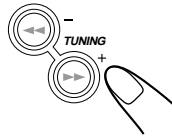

#### On the remote control:

Press and hold ◀◀ or ▶▶ for more than 1 second.

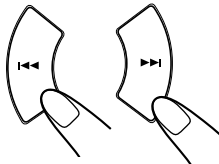

The unit starts searching for stations and stops when a station of sufficient signal strength is tuned in.

If a program is broadcast in stereo, the ST (stereo) indicator lights up.

To stop during searching, press TUNING + or TUNING – (or ◀◀ or ▶▶ on the remote control).



When you press TUNING + or TUNING – (or ◀◀ or ▶▶ on the remote control) briefly and repeatedly

The frequency changes step by step.

### To change the FM reception mode

When an FM stereo broadcast is hard to receive or noisy, press FM MODE on the remote control so that “MONO” appears and the MONO indicator lights up on the display. Reception improves.



To restore the stereo effect, press FM MODE again so that “STEREO” appears on the display and the MONO indicator goes off from the display.

In this stereo mode, you can hear stereo sounds when a program is broadcast in stereo.

## Presetting Stations

You can preset 30 FM, 8 MW, and 7 LW stations.

In some cases, test frequencies have been already memorized for the tuner since the factory examined the tuner preset function before shipment. This is not a malfunction. You can preset the stations you want into memory by following the presetting method.

- There is a time limit in doing the following steps. If the setting is canceled before you finish, start from step 1 again.

### On the unit ONLY:

#### 1 Tune in the station you want to preset.

- See “Tuning in a Station” above.

FM 87.50

#### 2 Press SET.

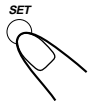

#### 3 Press PRESET + or PRESET – to select a preset number.

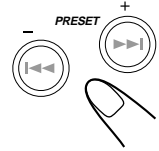

#### 4 Press SET again.

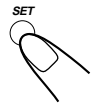

The tuned station in step 1 is stored in the preset number selected in step 3.

- Storing a new station on a used number erases the previously stored one.



When you unplug the AC power cord or if a power failure occurs

The preset stations will be erased in a few days. If this happens, preset the stations again.

## Tuning in a Preset Station

### 1 Press FM/AM.

The unit automatically turns on and tunes in the previously tuned station (FM, MW or LW).

- Each time you press the button, the band changes among FM, MW, and LW.

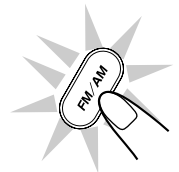

### 2 Select a preset number.

#### On the unit:

Press PRESET + or PRESET –.

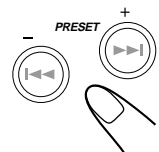

#### On the remote control:

Press the number buttons.

Ex.: For preset number 5, press 5.

For preset number 15, press +10, then 5.

For preset number 20, press +10, then 10.

For preset number 25, press +10, +10, then 5.

For preset number 30, press +10, +10, then 10.

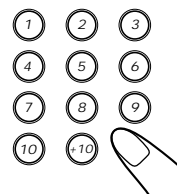

RDS allows FM stations to send an additional signal along with their regular program signals. For example, the stations send their station names, as well as information about what type of program they broadcast, such as sports or music, etc.

When tuned to an FM station which provides the RDS service, the RDS indicator lights up on the display.

With the unit, you can receive the following types of RDS signals.

**PS (Program Service):**

Shows commonly known station names.

**CT (Clock Time):**

Shows clock time the station sends.

**RT (Radio Text):**

Shows text messages the station sends.

**EON (Enhanced Other Networks):**

Provides the information about the types of the programs sent by other RDS stations.



**More about RDS**

- Some FM, MW, and LW stations do not provide RDS signals.
- RDS services vary among FM RDS stations. For details on RDS services in your area, check with local radio stations.
- RDS may not work correctly if the received station is not transmitting the signals properly or if the signal strength is weak.

## Changing the RDS Information

You can see RDS information on the display while listening to an FM station.

**Press DISPLAY MODE.**

- Each time you press the button, the display changes to show the following information:

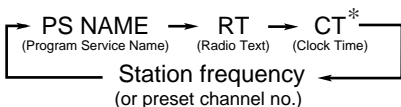
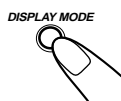

\* The clock time shown on the display is not the same as CT (Clock Time) sent by the station.



**If no PS NAME, CT or RT signals are sent by a station**

“NO PS,” “NO CT” or “NO RT” appears in the main display.

## Searching for Programs by PTY Codes (PTY Search)

One of the advantages of RDS is that you can locate a particular kind of program by specifying the PTY codes.

- For details on the PTY codes, see “Additional Information” on page 25.

**To search for a program using the PTY codes**

**REMEMBER** you must preset FM RDS stations to use the PTY codes. If not yet done, see page 11.

- There is a time limit in doing the following steps. If the setting is canceled before you finish, start from step 1 again.

**1 Press PTY/EON.**

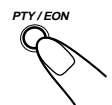

**2 Press SELECT + or SELECT - until the PTY code you want appears on the display.**

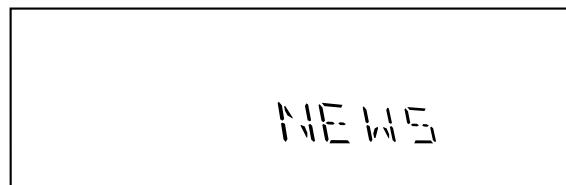
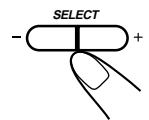

- Each time you press the button, the PTY codes change as follows:

- NEWS ⇄ AFFAIRS ⇄ INFO ⇄ SPORT ⇄ EDUCATE ⇄ DRAMA ⇄ CULTURE ⇄ SCIENCE ⇄ VARIED ⇄ POP M ⇄ ROCK M ⇄ M.O.R. M ⇄ LIGHT M ⇄ CLASSICS ⇄ OTHER M ⇄ WEATHER ⇄ FINANCE ⇄ CHILDREN ⇄ SOCIAL A ⇄ RELIGION ⇄ PHONE IN ⇄ TRAVEL ⇄ LEISURE ⇄ JAZZ ⇄ COUNTRY ⇄ NATIONAL ⇄ OLDIES ⇄ FOLK M ⇄ DOCUMENT ⇄ (back to the beginning)

**3 Press PTY/EON once again.**

The preset FM stations appear on the display with their preset numbers.

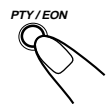

The unit searches 30 preset FM stations, stops when it finds the one you have selected, and tunes in that station.

- If no program is found, the unit returns to the last received station.

**To stop searching any time during the process**

Press SELECT + or SELECT - while searching.

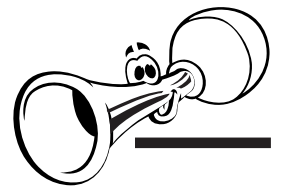

## Switching to a Traffic Announcement Temporarily

By receiving EON data sent by FM RDS stations, the EON function allows the unit to switch temporarily to a broadcast of a traffic announcement from a different station.

- The EON function only works when you are listening to a preset FM RDS stations providing EON data.
- The EON indicator lights while receiving a station with EON data.

### To activate the EON function

**REMEMBER** you must preset FM RDS stations to use the EON function. If not yet done, see page 11.

### 1 Press and hold PTY/EON.

Each time you press and hold PTY/EON, “TA ON” and “TA OFF” alternately appear on the display.

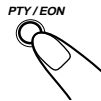

TA ON ↔ TA OFF

**TA ON:** Switches to a traffic announcement, if any.

**TA OFF:** This function is canceled.

### How the EON function actually works:

#### CASE 1

##### If there is no station broadcasting a traffic announcement

The unit continues tuning in the current station.



When a station starts broadcasting a traffic announcement, the unit automatically switches to the station. The TA indicator starts flashing.



When the program is over, the unit goes back to the previously tuned station, but the EON function still remains activated.

#### CASE 2

##### If there is a station broadcasting a traffic announcement

The unit tunes in the program. The TA indicator starts flashing.



When the program is over, the unit goes back to the previously tuned station, but the EON function still remains activated.

#### CASE 3

##### If the FM station you are listening to is broadcasting a traffic announcement

The unit continues to receive the station but the TA indicator starts flashing.



When the program is over, the TA indicator stops flashing, but the EON function still remains activated.



#### More about the EON function

- EON data sent from some stations may not be compatible with this unit. In this case, the EON function may not work correctly.
- While listening to a program tuned in by the EON function, the station does not change even if another network station starts broadcasting a program of the same EON data.
- The EON function is canceled when you change the source to CD, TAPE or AUX, while it is temporarily canceled when you change the source to MW or LW.



# Playing Back CDs

This unit has been designed to playback the following CDs: Audio CD, CD-R, and CD-RW.

Continued use of irregular shape CDs (heart-shape, octagonal, etc.) can damage the unit.

### When playing a CD-R or CD-RW

User-edited CD-Rs (Recordable) and CD-RWs (Rewritable) can be played back only if they are already "finalized."

- You can play back your original CD-Rs or CD-RWs recorded in music CD format. (However, they may not be played back depending on their characteristics or recording conditions.)
- Before playing back CD-Rs or CD-RWs, read their instructions or cautions carefully.
- Some CD-Rs or CD-RWs may not be played back on this unit because of their disc characteristics, damage or stain on them, or if the player's lens is dirty.
- CD-RWs may require a longer readout time. (This is caused by the fact that the reflectance of CD-RWs is lower than for regular CDs.)

## Loading CDs

### 1 Press .

The unit automatically turns on and the carousel comes out.



### 2 Place one or two discs correctly on the front slots of the carousel, with its label side up.

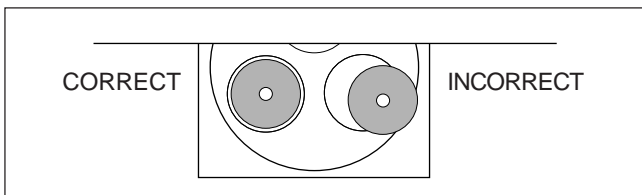

- When using a CD single (8 cm), place it on the inner circle of the disc tray.

### 3 If you wish to load a third disc, press **DISC CHANGE** on the unit or **DISC SKIP** on the remote control.

The carousel rotates by 120°.



### 4 Press again.

The carousel closes.



### About the disc indicators

Each disc indicator corresponds to the disc tray of the same number.

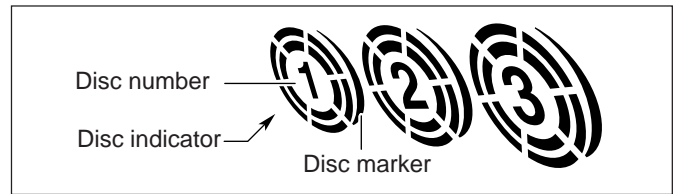

- The disc marker lights up for the disc number you have selected.
- The disc indicator rotates while the corresponding CD is being played.
- The disc indicator goes off when the unit has detected that there is no CD on the corresponding disc tray.

## Playing Back the Entire Discs — Continuous Play

You can play CDs continuously.

### 1 Load CDs.

### 2 Press one of the disc number buttons (CD1, CD2 or CD3) for the disc you want to play.

CD play starts from the first track of the selected disc.

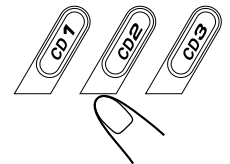

Track number of the currently playing disc is flashing. (Track numbers exceeding 16 are not displayed.)

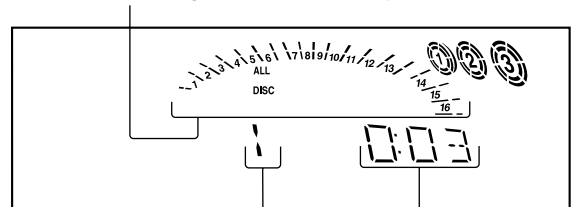

Track number Elapsed playing time

- Pressing CD  instead of the disc number buttons starts playing back if a CD is on the tray.

When you turn on the unit, ALL DISC indicator lights up on the display automatically. If you do not want all the CDs to play back, select 1 DISC by pressing REPEAT.

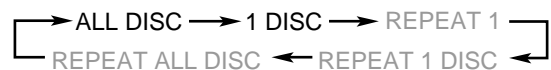

- ALL DISC:** Plays all loaded CD.
- 1 DISC:** Plays back one CD.

To stop during play, press .

To remove the disc, press .



### CD playback sequence (when ALL DISC is selected)

When 3 CDs are loaded on the disc trays, they are played in one of the following sequences.

- When CD1 is pressed : CD1 ⇒ CD2 ⇒ CD3 (then stops)
- When CD2 is pressed : CD2 ⇒ CD3 ⇒ CD1 (then stops)
- When CD3 is pressed : CD3 ⇒ CD1 ⇒ CD2 (then stops)

\* When only 2 CDs are loaded, they are played in the same order, but the disc tray without a CD is skipped.

## Basic CD Operations

While playing a CD, you can do the following operations.

### To exchange CDs during playback of another

Press DISC CHANGE to change the CD, and the carousel comes out.

If you change CDs during play, the current play will not stop until all CDs you have changed are played.



To close the carousel, press DISC CHANGE or ▲.

### To skip to the another CD in the carousel

Press DISC SKIP on the remote control.



### To stop play for a moment

Press CD ►/II.

While pausing, "PAUSE" appears on the display.

To resume play, press CD ►/II again.



### To locate a particular point in a track

During play, press and hold ◀◀ or ▶▶.

- ◀◀: Fast reverses the disc.
- ▶▶: Fast forwards the disc.

When using the remote control, press and hold ◀◀ or ▶▶.

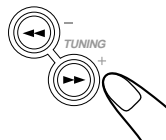

### To go to another track

Press ◀◀ or ▶▶ repeatedly before or during playback.

- ◀◀: Goes back to the beginning of the current or previous tracks.
- ▶▶: Skips to the beginning of the next or succeeding tracks.

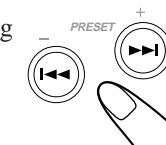

If you press and hold ◀◀ or ▶▶ on the unit before or during play

You can change the tracks continuously.

### To go to another track directly using the number buttons

Pressing the number button(s) before or during play allows you to start playing the track number you want.

- Ex.: For track number 5, press 5.  
 For track number 15, press +10, then 5.  
 For track number 20, press +10, then 10.  
 For track number 32, press +10, +10, +10, then 2.

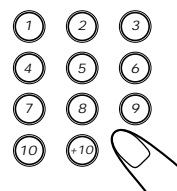

## Programming the Playing Order of the Tracks — Program Play

You can arrange the order in which the tracks play before you start playing. **You can program up to 32 tracks.**

- To use Repeat play (see page 16) for Program play, press REPEAT after starting Program play.

### On the unit ONLY:

#### 1 Load CDs.

- If the current playing source is not the CD player, press CD ►/II, then ■ before going to the next step.

#### 2 Press PROGRAM so that "PROGRAM" appears on the display.

The PRGM (program) indicator also lights up on the display.



- If a program has been stored in memory, the program is called up.

#### 3 Press one of the disc number buttons (CD1, CD2 or CD3) to select the disc number you want to play.

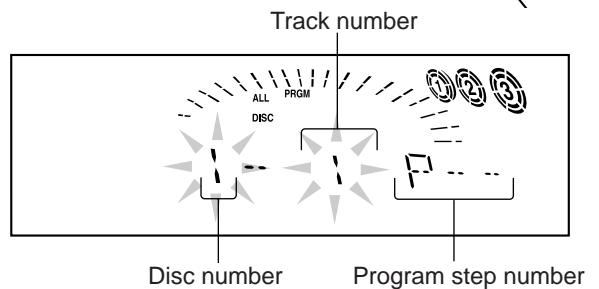
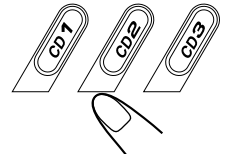

#### 4 Press ◀◀ or ▶▶ to select the track number, then press SET.

Each time you select a track and press SET, the selected track number is added to the CD track number indicator.

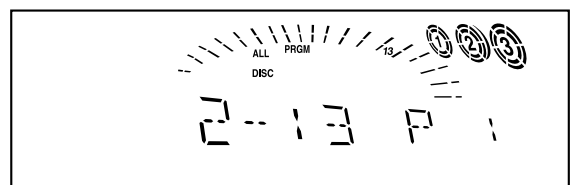
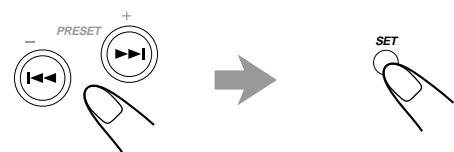



## 5 Program other tracks you want.

- To program tracks from the same disc, repeat step 4.
- To program tracks from a different disc, repeat steps 3 and 4.

## 6 Press CD ►/II.

The tracks are played in the order you have programmed.



To stop during play, press ■.

To exit from Program play mode, press PROGRAM again before or after play so that the unit enters Continuous play mode. (The program you have made is stored in memory until you turn off the unit or erase the program.)

### To modify the program

Before playing, you can erase the programmed tracks shown on the display by pressing CANCEL.

- Each time you press the button, the last programmed track is erased from the program.



To check the program during play, press ►► (or ◀◀) so that the playing track will change according to the program (or reverse) order.

To add tracks in the program before play, simply select the disc numbers and/or track numbers you want to add by following steps 3 and 4 of the programming procedure on page 15.

To erase the entire program before or during play, press ■ twice.

- Ejecting a carousel will also erase the stored memory.



If you try to program a 33rd track "FULL" will appear on the display.



If your entry is ignored

You have tried to program a track from an empty tray, or a track number that does not exist on the CD. Such entries are ignored.

## Playing at Random — Random Play

The tracks of the selected CD will play at random.

### 1 Load a CD.

- If the current playing source is not the CD player, press CD ►/II, then ■ before going to the next step.

### 2 Press RANDOM so that "RANDOM" appears on the display.

The RANDOM indicator also lights up on the display.

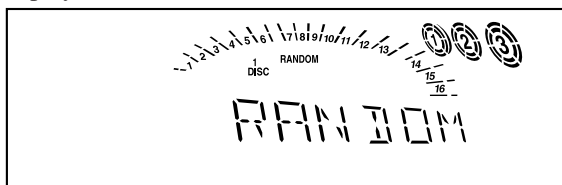

- The tracks are played automatically at random. Random play ends when all tracks are played once.

To stop during play, press ■.

- Random play also stops when ▲ is pressed.

To exit from Random play mode, press RANDOM again during play so that the unit enters Continuous play mode.

To use Random play mode, you have to exit from the Program play mode.



If you press ◀◀ or ►►

Skips to the next track selected randomly.

## Repeating Tracks or CDs — Repeat Play

You can have all the CDs, the program or the individual track currently playing repeat as many times as you like.

To repeat play, press REPEAT during or before playing.

- Each time you press the button, Repeat play mode changes as follows, and the following indicator lights up on the display:



**REPEAT 1:** Repeats one track on one CD.

**REPEAT 1 DISC\*:** Repeats all the tracks on one CD.

**REPEAT ALL DISC:** Repeats all the tracks on all the CDs.

\* REPEAT 1 DISC is not used for Program play.

To cancel Repeat play, press REPEAT repeatedly until the REPEAT indicator (REPEAT 1, REPEAT 1 DISC or REPEAT ALL DISC) goes off from the display.

- Repeat play and Random play cannot be used at the same time.

## Prohibiting Disc Ejection — Tray Lock

You can prohibit CD ejection from the unit and lock CDs.

- This operation is possible only while the unit is on with CD selected as the source.

### On the unit ONLY:

To prohibit disc ejection, press ▲ for the carousel while holding ■.

"LOCKED" appears for a while, and the carousel is locked.

To cancel the prohibition and unlock the CDs, press ▲ for the carousel while holding ■.

"UNLOCKED" appears for a while, and the carousel is unlocked.



If you try to eject CDs

"LOCKED" appears to inform you that the Tray Lock is in use.

# Playing Back Tapes



## Playing Back a Tape

**1 Press EJECT (▲) for the deck you want to use.**

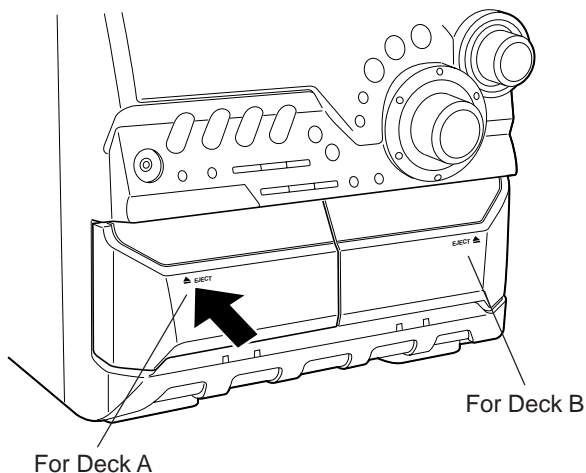

**2 Put a cassette in with the exposed part of the tape down.**

- You can play back only type I.

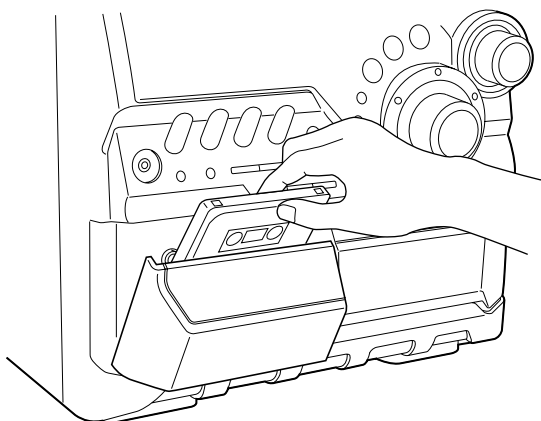

To stop during play, press ■.

To operate the other deck, press TAPE A or TAPE B (or TAPE A/B on the remote control), then TAPE ►.

To fast-forward the tape, press ►► (or ►►| on the remote control). The tape direction indicator (►) starts flashing quickly.

To rewind the tape, press ◀◀ (or |◀◀ on the remote control). The tape direction indicator (◀) starts flashing quickly.

To remove the cassette, press ▲ EJECT for deck A or EJECT ▲ for deck B.

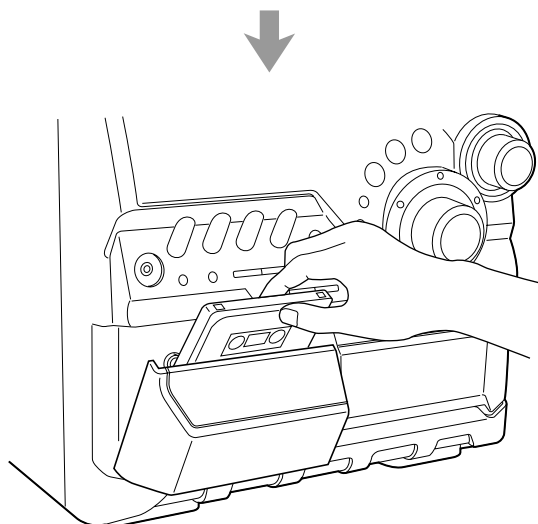
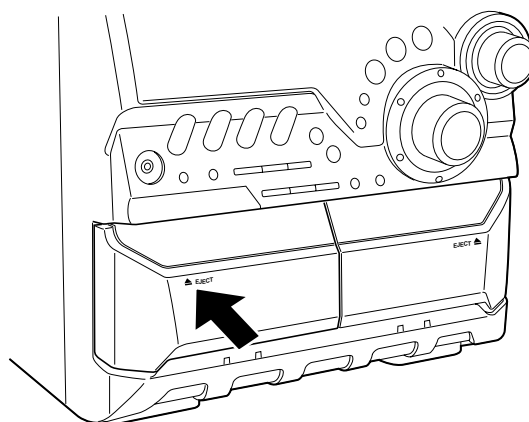

**3 Close the cassette holder gently.**

If you put cassettes in both decks A and B, the last deck which you have put a cassette into is selected.

To operate the other deck, press TAPE A or TAPE B (or TAPE A/B on the remote control).

**4 Press TAPE ►.**

The tape play starts and the tape running indicator (►) starts flashing slowly.

When the tape plays to the end, the deck automatically stops.

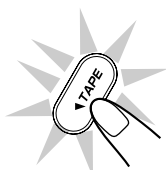

The use of the C-120 or thinner tape is not recommended, since characteristic deterioration may occur and this tape easily jams in the pinch-rollers and the capstans.

**IMPORTANT:**

- It should be noted that it may be unlawful to re-record pre-recorded tapes, records, or discs without the consent of the owner of copyright in the sound or video recording, broadcast or cable programme and in any literary, dramatic, musical, or artistic embodied therein.
- The recording level is automatically set correctly, so it is not affected by the VOLUME control, the SOUND MODE control, and the ACTIVE BASS EX. LEVEL control. Thus, during recording you can adjust the sound you are actually listening to without affecting the recording level.
- While recording, you can hear sound modes through the speakers or headphones. However, the sound is recorded without these effects (see page 10).
- If recordings you have made have excessive noise or static, the unit may be too close to a TV. Place the unit away from the TV.
- You can use type I tape for recording.

**To protect your recording**

Cassettes have two small tabs on the back to protect unexpected erasure or re-recording.

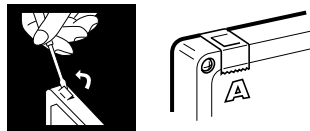

To protect your recording, remove these tabs.

To re-record on a protected tape, cover the holes with adhesive tape.

**To keep the best recording and playback sound quality**

If the heads, capstans, and pinch rollers of the cassette decks become dirty, the following will occur:

- Impaired sound quality
- Discontinuous sound
- Fading
- Incomplete erasure
- Difficulty in recording

**To clean the head, capstan, and pinch roller**

Use a cotton swab moistened with alcohol.

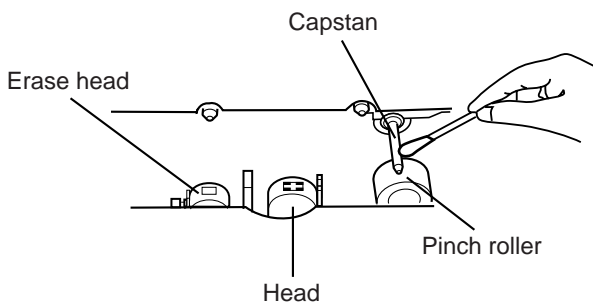

**To demagnetize the head**

Turn off the unit, and use a head demagnetizer (available at electronics and record shops).

## Recording a Tape on Deck B

**On the unit ONLY:**

**1 Press EJECT ▲ for the deck B.**

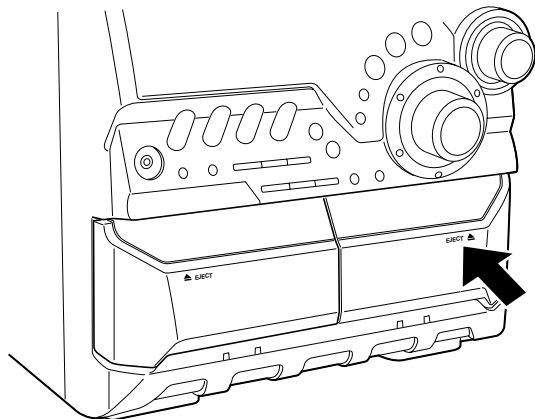

**2 Put a recordable cassette in with the exposed part of the tape down.**

**3 Close the cassette holder gently.**

**4 Start playing the source — FM, MW, LW, CD player or auxiliary equipment connected to AUX IN jacks.**

- When you want to use the dubbing method, see “Dubbing Tapes” on page 19.
- When the source is CD, you can also use CD Synchro Recording (see “CD Synchro Recording” on page 19.)

**5 Press REC START/STOP.**

The REC (recording) indicator lights up on the display and recording starts.



**To stop during recording, press REC START/STOP again or ■.**

**To remove the cassette, press EJECT ▲ for deck B.**



## Dubbing Tapes

### On the unit ONLY:

1 Press TAPE ►, then ■.

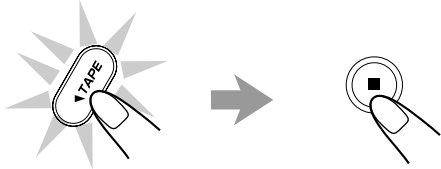

2 Put the source cassette into deck A, and a recordable cassette into deck B.

3 Press DUBBING.

Dubbing starts.  
“DUBBING” appears, and the REC (recording) indicator lights up on the display.

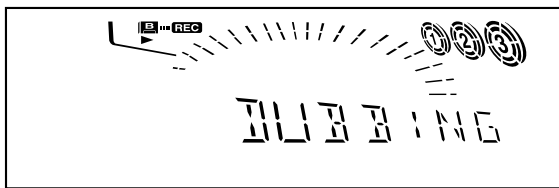
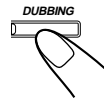

To stop during dubbing, press ■.

To remove the cassette, press ▲ EJECT for deck A and EJECT ▲ for deck B.

## CD Synchronized Recording

You can easily record a CD onto a tape.

- You can also record the tracks in order you have made the program.

### On the unit ONLY:

1 Put a recordable cassette into deck B.

2 Place a disc correctly on the circle of the disc tray, with its label side up.

3 Press one of the disc number buttons (CD1, CD2 or CD3) to select the disc, then ■.

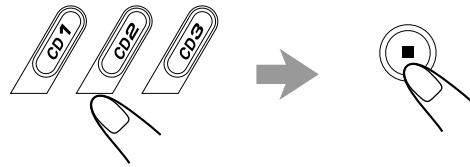

4 Press CD REC START.

“CD REC” appears, and the REC (recording) indicator lights up on the display.

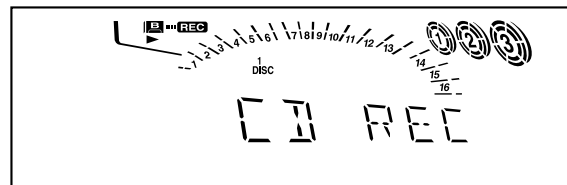
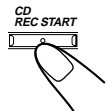

Deck B starts recording and the CD player starts playing. When the recording is done, the CD player and deck B stop.

To stop during CD Synchro Recording, press ■.

To remove the cassette, press EJECT ▲ for deck B.

There are three timers available — Daily Timer, Recording Timer, and Sleep Timer.

Before using the timers, you need to set the clock built in the unit. (See “Setting the Clock” on page 9.)

## Using Daily Timer

With Daily Timer, you can wake to your favorite music or radio program. You can set the timer whether the unit is on or off.

### How Daily Timer actually works

The unit automatically turns on, set the volume level to the preset level, and starts playing the specified source when the on-time comes (the ☺ indicator flashes while the timer is operating). Then, when the off-time comes, the unit automatically turns off (stands by).

The timer setting remains in memory until you change it.

- There is a time limit in doing the following steps. If the setting is canceled before you finish, start from step 1 again.
- If you have made a mistake while setting timer, press CANCEL. (However, this does not always work. If CANCEL does not work, press CLOCK/TIMER repeatedly and start from step 1 again.)

#### Before you start...

- *When using a CD as the source to play —*  
– Make sure there is a CD on the currently selected disc number tray.
- *When using a tape as the source to play —*  
– Make sure that a tape is in the deck whose deck indicator (A or B) is lit on the display.
- *When using the external component as the source to play —*  
– Set the timer equipped with the external component at the same time.

### On the unit ONLY:

#### 1 Press CLOCK/TIMER repeatedly until “DAILY” appears on the display.

☺ indicator lights up and the DAILY (daily timer) indicator also starts flashing on the display.

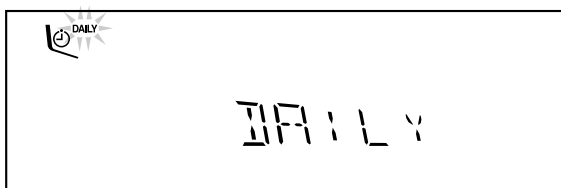

- Each time you press the button, the timer setting modes change as follows:

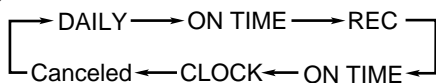

(See page 9.)

#### 2 Press CLOCK/TIMER again.

“ON TIME” appears for 2 seconds, then the unit enters on-time setting mode.

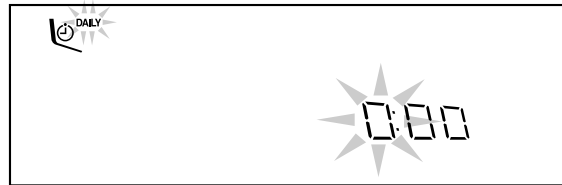

#### 3 Set the on-time you want the unit to turn on.

- 1) Press ◀◀ or ▶▶ to set the hour, then press SET.
  - 2) Press ◀◀ or ▶▶ to set the minute, then press SET.
- “OFF TIME” appears for 2 seconds, then the unit enters off-time setting mode.

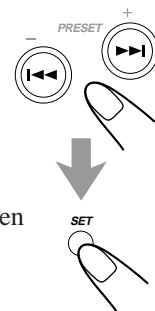

#### 4 Set the off-time you want the unit to turn off (on standby).

- 1) Press ◀◀ or ▶▶ to set the hour, then press SET.
  - 2) Press ◀◀ or ▶▶ to set the minute, then press SET.
- The unit enters source selecting mode.

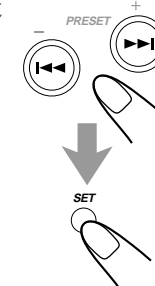

#### 5 Press ◀◀ or ▶▶ to select the source to play, then press SET.

- Each time you press ◀◀ or ▶▶, the source changes as follows:

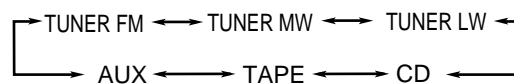

TUNER FM: tunes into a specified preset FM station. → go to step 6.

TUNER MW: tunes into a specified preset MW station. → go to step 6.

TUNER LW: tunes into a specified preset LW station. → go to step 6.

CD: plays a disc from the first track. → go to step 7.

TAPE: plays a tape in deck A or B. → go to step 7.

AUX: plays an external source. → go to step 7.

## 6 Select the preset station number.

Press **◀◀** or **▶▶** to select the preset station number, then press **SET**.  
The unit enters volume setting mode.

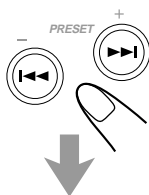

## 7 Press **◀◀** or **▶▶** to set the volume level.

- You can select the volume level from VOL MIN, VOL 1 — VOL 30, and VOL MAX.

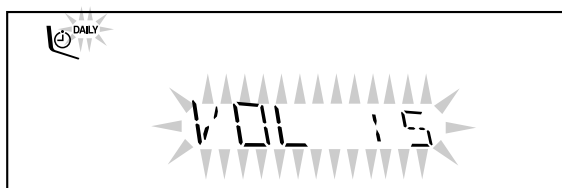
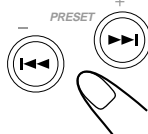

## 8 Press **SET** to complete the Daily Timer setting.

The DAILY (daily timer) indicator stops flashing and remains lit. The settings you have done are shown on the display in sequence for your confirmation.

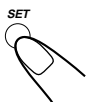

## 9 Press **⏻/STANDBY/ON** to turn off the unit (on standby) if you have set the Daily Timer with the unit turned on.

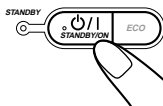

If the unit is turned on when the timer-on time comes Daily Timer does not work.

To turn on or off Daily Timer after its setting is done

### 1 Press **CLOCK/TIMER** repeatedly until “DAILY” appears on the display.



### 2 To turn off the Daily Timer, press **CANCEL**.



The DAILY (daily timer) indicator goes off from the display (“OFF” appears for a while). The Daily Timer is canceled, but the setting for the Daily Timer remains in memory.

### To turn on the Daily Timer, press **SET**.

The DAILY (daily timer) indicator lights up on the display. The settings you have done are shown on the display in sequence for your confirmation.

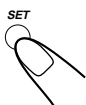

## Using Recording Timer

With Recording Timer, you can make a tape of a radio broadcast automatically. You can set the timer whether the unit is on or off.

### How Recording Timer actually works

The unit automatically turns on, tunes into the specified station, sets the volume level to “VOL MIN,” and starts recording when the on-time comes (the  indicator flashes while the timer is operating). Then, when the off-time comes, the unit automatically turns off (stands by).

The timer setting remains in memory until you change it.

- There is a time limit in doing the following steps. If the setting is canceled before you finish, start from step 1 again.
- If you have made a mistake while setting the timer, press **CANCEL**. (However, this does not always work. If **CANCEL** does not work, press **CLOCK/TIMER** repeatedly and start from step 1 again.)

### On the unit ONLY:

#### 1 Put a recordable cassette into deck B.

#### 2 Press **CLOCK/TIMER** repeatedly until “REC” appears on the display.



 indicator lights up and the REC (recording timer) indicator also starts flashing on the display.



- Each time you press the button, the timer setting modes change as follows:

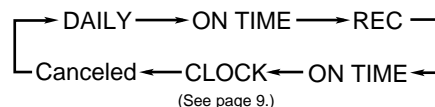

#### 3 Press **CLOCK/TIMER** again.

“ON TIME” appears for 2 seconds, then the unit enters on-time setting mode.

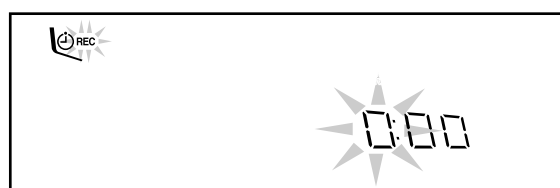





#### 4 Set the on-time you want the unit to turn on.

- 1) Press **◀** or **▶** to set the hour, then press **SET**.
- 2) Press **◀** or **▶** to set the minute, then press **SET**.  
“OFF TIME” appears for 2 seconds, then the unit enters off-time setting mode.

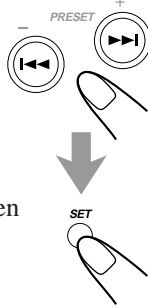

#### 5 Set the off-time you want the unit to turn off (on standby).

- 1) Press **◀** or **▶** to set the hour, then press **SET**.
- 2) Press **◀** or **▶** to set the minute, then press **SET**.  
The unit enters preset station selecting mode.

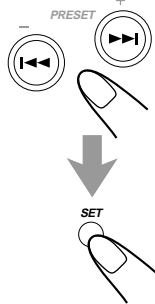

#### 6 Select the preset station.

- 1) Press **◀** or **▶** to select the band (“TUNER FM,” “TUNER MW” or “TUNER LW”), then press **SET**.
- 2) Press **◀** or **▶** to select a preset channel number, then press **SET**.  
The REC (recording timer) indicator stops flashing and remains lit. The settings you have done are shown on the display in sequence for your confirmation.

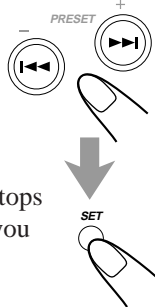

#### 7 Press **⏻/STANDBY/ON** to turn off the unit (on standby) if necessary.

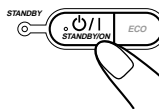

**notes** If you want to listen to another source while recording Press **REC START/STOP** or **■** to stop recording. Without stopping it, you cannot change the source.

To turn on or off Recording Timer after its setting is done

- 1 Press **CLOCK/TIMER** repeatedly until “**REC**” appears on the display.



- 2 To turn off the Recording Timer, press **CANCEL**.

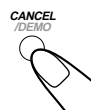

The REC (recording timer) indicator goes off from the display (“OFF” appears for a while). The Recording Timer is canceled, but the setting for the Recording Timer remains in memory.

To turn on the Recording Timer, press **SET**. The REC (recording timer) indicator lights up on the display. The settings you have done are shown on the display in sequence for your confirmation.

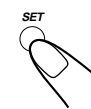

## Using Sleep Timer

With Sleep Timer, you can fall asleep to music. You can set Sleep Timer when the unit is turned on.

### How Sleep Timer actually works

The unit automatically turns off after the specified time length passes.

### On the remote control ONLY:

#### 1 Press **SLEEP**.

The time length until the shut-off time appears and the SLEEP indicator starts flashing on the display.



- Each time you press the button, the time length changes as follows:

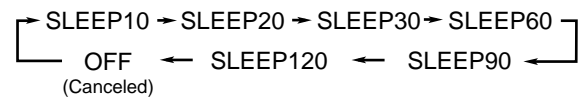

#### 2 Wait for about 5 seconds after specifying the time length.

The SLEEP indicator stops flashing and remains lit.

To check the remaining time until the shut-off time, press **SLEEP** once so that the remaining time until the shut-off time appears for about 5 seconds.

To change the shut-off time, press **SLEEP** repeatedly until the desired time length appears on the display.

To cancel the setting, press **SLEEP** repeatedly until “OFF” appears on the display so that the SLEEP indicator goes off from the display.

- Sleep Timer is also canceled when you turn off the unit.

## Timer Priority

Since each timer can be set separately, you may wonder what happens if the setting for these timers overlaps. Here are examples.

- **Recording Timer has priority over Daily Timer.**

If Daily Timer is set to come on while Recording Timer is operating, Daily Timer will not come on at all.

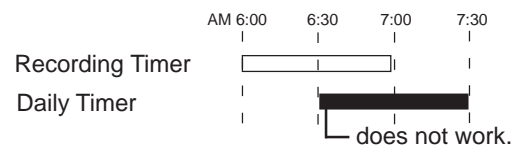

- If Sleep Timer overlaps with another timer (either Daily Timer or Recording Timer), a timer with the earlier shut-off time has priority.

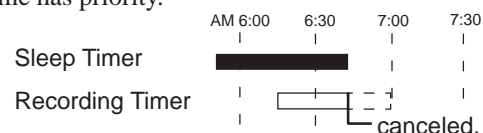

When using the Recording Timer and Sleep Timer at the same time, pay special attention to the shut-off time.

# Maintenance



To get the best performance of the unit, keep your discs, tapes, and mechanism clean.

## Handling discs



- Remove the disc from its case by holding it at the edge while pressing the center hole lightly.
- Do not touch the shiny surface of the disc, or bend the disc.
- Put the disc back in its case after use to prevent warping.

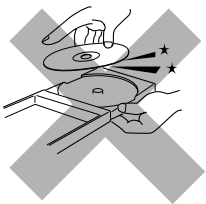

- Be careful not to scratch the surface of the disc when placing it back in its case.
- Avoid exposure to direct sunlight, temperature extremes, and moisture.



### To clean the disc

Wipe the disc with a soft cloth in a straight line from center to edge.



DO NOT use any solvent — such as conventional record cleaner, spray, thinner, or benzine — to clean the disc.

## Handling cassette tapes

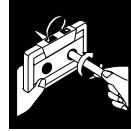

- If the tape is loose in its cassette, take up the slack by inserting a pencil in one of the reels and rotating.
- If the tape is loose, it may get stretched, cut, or caught in the cassette.



- Be careful not to touch the tape surface.



- Avoid the following places to store the tape:
  - In dusty places
  - In direct sunlight or heat
  - In moist areas
  - Near a magnet

# Troubleshooting



If you are having a problem with your unit, check this list for a possible solution before calling for service.

If you cannot solve the problem from the hints given here, or the unit has been physically damaged, call a qualified person, such as your dealer, for service.

Symptom	Cause	Action
Unable to cancel the display demonstration.	Other buttons are pressed to cancel the display demonstration.	Press DEMO on the unit. (See page 8.)
No sound is heard.	Connections are incorrect or loose.	Check all connections and make corrections. (See pages 6 to 8.)
Hard to listen to broadcasts because of noise.	<ul style="list-style-type: none"> <li>Antennas are disconnected.</li> <li>The AM (MW/LW) loop antenna is too close to the unit.</li> <li>The FM antenna is not properly extended and positioned.</li> </ul>	<ul style="list-style-type: none"> <li>Reconnect the antennas correctly and securely.</li> <li>Change the position and direction of the AM (MW/LW) loop antenna.</li> <li>Extend the FM antenna at the best position.</li> </ul>
The disc sound is discontinuous.	The disc is scratched or dirty.	Clean or replace the disc. (See page 23.)
The carousel does not open or close.	<ul style="list-style-type: none"> <li>The AC power cord is not plugged in.</li> <li>The carousel is locked.</li> </ul>	<ul style="list-style-type: none"> <li>Plug the AC power cord.</li> <li>Unlock the carousel. (See page 16.)</li> </ul>
The disc does not play.	The disc is placed upside down.	Place the disc with the label side up.
The cassette holders cannot be opened.	Power supply from the AC power cord has been cut off while the tape was running.	Turn on the unit.
Impossible to record.	Small tabs on the back of the cassette are removed.	Cover the holes with adhesive tape.
Operations are disabled.	The built-in microprocessor may malfunction due to external electrical interference.	Unplug the AC power cord and then plug it back in.
Unable to operate the unit from the remote control.	<ul style="list-style-type: none"> <li>The path between the remote control and the remote sensor on the unit is blocked.</li> <li>The batteries are exhausted.</li> </ul>	<ul style="list-style-type: none"> <li>Remove the obstruction.</li> <li>Replace the batteries.</li> </ul>

# Additional Information

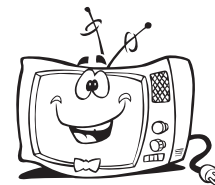

## Description of the PTY codes:

<b>NEWS:</b>	News.	<b>FINANCE:</b>	Stock Market reports, commerce, trading etc.
<b>AFFAIRS:</b>	Topical program expanding or enlarging upon the news — debate, or analysis.	<b>CHILDREN:</b>	Programs targeted at a young audience.
<b>INFO:</b>	Program the purpose of which is to impart advice in the widest sense.	<b>SOCIAL A:</b>	Programs about sociology, history, geography, psychology and society.
<b>SPORT:</b>	Program concerned with any aspect of sports.	<b>RELIGION:</b>	Religious programs.
<b>EDUCATE:</b>	Educational programs.	<b>PHONE IN:</b>	Involving members of the public expressing their views either by phone or at a public forum.
<b>DRAMA:</b>	All radio plays and serials.	<b>TRAVEL:</b>	Travel information.
<b>CULTURE:</b>	Programs concerning any aspect of national or regional culture, including language, theatre, etc.	<b>LEISURE:</b>	Programs about recreational activities.
<b>SCIENCE:</b>	Programs about natural sciences and technology.	<b>JAZZ:</b>	Jazz music.
<b>VARIED:</b>	Used for mainly speech-based programs like quizzes, panel games and personality interviews.	<b>COUNTRY:</b>	Songs which originate from, or continue the musical tradition of the American Southern States.
<b>POP M:</b>	Commercial music of current popular appeal.	<b>NATIONAL:</b>	Current popular music of the nation or region in that country's language.
<b>ROCK M:</b>	Rock music.	<b>OLDIES:</b>	Music from the so-called "golden age" of popular music.
<b>M.O.R. M:</b>	Current contemporary music considered to be "easy-listening."	<b>FOLK M:</b>	Music which has its roots in the musical culture of a particular nation.
<b>LIGHT M:</b>	Instrumental music, and vocal or choral works.	<b>DOCUMENT:</b>	Program concerning factual matters, presented in an investigative style.
<b>CLASSICS:</b>	Performances of major orchestral works, symphonies, chamber music, etc.		
<b>OTHER M:</b>	Music not fitting into any of the other categories.		
<b>WEATHER:</b>	Weather reports and forecasts.		

**Classification of the PTY codes for some FM stations may be different from the above list.**

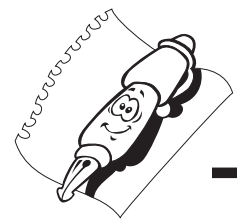

## Amplifier section — CA-MXK5R

Output Power (IEC268-3/DIN)

**65 W per channel, min. RMS, driven into 6  $\Omega$  at 1 kHz with no more than 10% total harmonic distortion.**

Audio input sensitivity/Impedance (at 1 kHz)

AUX: 530 mV/50 k $\Omega$

Digital output: DIGITAL OUT (OPTICAL)

Signal wave length: 660 nm

Output level: -21 dBm to -15 dBm

Speakers/Impedance: 6  $\Omega$  — 16  $\Omega$

## Tuner

FM tuning range: 87.50 MHz — 108.00 MHz

AM tuning range: MW: 522 kHz — 1 629 kHz

LW: 144 kHz — 288 kHz

## CD player

CD Capacity: 3 CDs

Dynamic range: 85 dB

Signal-to-noise ratio: 85 dB

## Cassette deck

Frequency response

Normal (type I): 50 Hz — 14 000 Hz

Wow and flutter

0.15% (WRMS)

## General

Power requirement: AC 230 V $\sim$ , 50 Hz

Power consumption: 120 W (at operation)

17 W (on standby)

3.5 W (at eco mode)

Dimensions (approx.): 270 mm x 317 mm x 447 mm (W/H/D)

(10<sup>11/16</sup> in. x 12<sup>1/2</sup> in. x 17<sup>5/8</sup> in.)

Mass (approx.): 8.6 kg (19.0 lbs)

## Supplied accessories

See page 6.

Design and specifications are subject to change without notice.

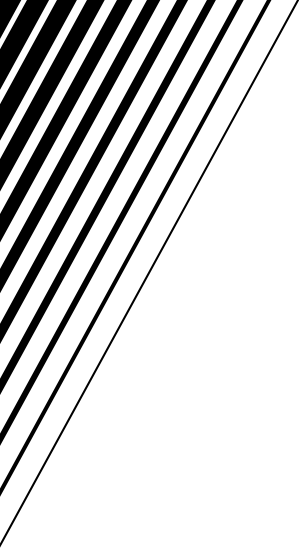

**JVC**  
VICTOR COMPANY OF JAPAN, LIMITED

# JVC INSTRUCTIONS

## SPEAKER SYSTEM

### SP-MXK5R

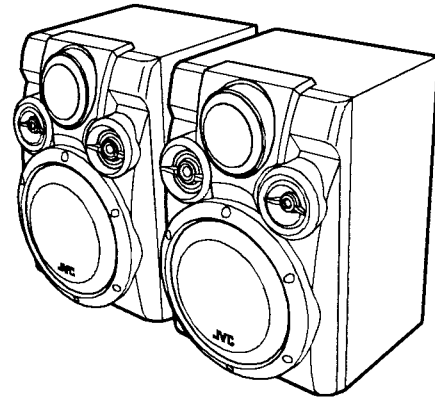
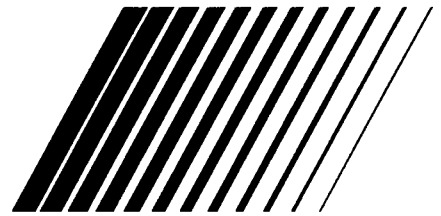

**BEDIENUNGSANLEITUNG: LAUTSPRECHERSYSTEM**  
**MANUEL D'INSTRUCTIONS: SYSTEME DES ENCEINTES**  
**GEBRUIKSAANWIJZING: LUIDSPREKERSYSTEEM**  
**MANUAL DE INSTRUCCIONES: SISTEMA DE ALTAVOCES**  
**ISTRUZIONI: SISTEMA DI ALTOPARLANTI**  
**BRUKSANVISNING: HÖGTALARSYSTEM**  
**KÄYTTÖOHJE: KAIUTINJÄRJESTELMÄ**  
**VEJLEDNING: HØJTTALERSYSTEM**  
**HASZNÁLATI ÚTMUTATÓ: HANGSZÓRÓ RENDSZER**  
**INSTRUKCJA UŻYTKOWANIA: ZESTAW GŁOŚNIKOWY**  
**NÁVOD K OBSLUZE: REPRODUKTOROVÁ SOUSTAVA**

Thank you for purchasing JVC speakers.

Before you begin using them, please read the instructions carefully to be sure you get the best possible performance. If you have any questions, consult your JVC dealer.

Vielen Dank für den Kauf dieser JVC-Lautsprecher.

Lesen Sie bitte diese Bedienungsanleitung vor Ingebrauchnahme sorgfältig durch, um stets optimale Ergebnisse zu erzielen. Wenden Sie sich bei etwaigen Fragen bitte an Ihren JVC Händler.

Nous vous remercions pour l'achat de ces enceintes JVC.

Avant de les utiliser, lire ces instructions avec attention pour en obtenir les meilleures performances possibles. En cas de questions, consulter votre revendeur JVC.

Dank u voor de aanschaf van deze JVC luidsprekers.

Lees alvorens over te gaan tot aansluiten, deze gebruiksaanwijzing door zodat u de best mogelijke prestaties zult verkrijgen. Neem contact op met de JVC dealer indien u vragen heeft.

Le estamos muy agradecidos por haber adquirido estos altavoces de JVC.

Antes de utilizarlos, sírvase leer las instrucciones detenidamente a fin de obtener el mejor rendimiento posible. Si tienen alguna pregunta, acuda a su agente de JVC.

Grazie per aver acquistato questi altoparlanti della JVC.

Prima di cominciare l'uso degli altoparlanti, leggete attentamente le istruzioni per assicurare le migliori prestazioni. Qualora sorgessero dei dubbi, rivolgetevi al vostro rivenditore JVC.

Tack för ditt val av dessa JVC-högtalare.

Innan du kopplar in högtalarna i din ljudanläggning bör du för att få maximala prestanda från högtalarna läsa igenom bruksanvisningen noggrant. Kontakta din JVC-återförsäljare om du har frågor eller känner dig osäker.

Kiitos siitä että päädyit valinnassasi JVC-kaiuttimiin.

Ennen kuin alat käyttää niitä, lue käyttöohje huolellisesti, jotta ne toimisivat parhaalla mahdollisella tavalla. Jos Sinulla on kysyttävää ota yhteyts JVC-edustajaan.

Tak for købet af JVC-højttalere.

Gennemlæs venligst vejledningen omhyggeligt før de tages i brug, så De kan opnå den bedst mulige ydelse. Forhør hos Deres JVC forhandler hvis De har nogen spørgsmål.

Köszönjük, hogy a JVC hangszóró rendszerét választotta. Annak érdekében, hogy a hangszóró rendszer a legjobb teljesítményt nyújtsa Önnek, használat előtt kérjük figyelmesen olvassa el ezt a használati útmutatót. Ha bármilyen kérdése van, forduljon a legközelebbi JVC márkakereskedőhöz.

Dziękujemy za wybranie zestawu głośnikowego firmy JVC.

Przed rozpoczęciem użytkowania zestawu głośnikowego prosimy o dokładne zapoznanie się z treścią niniejszej instrukcji użytkowania, aby uzyskać jak najlepszą pracę głośników. W przypadku jakichkolwiek zapytań, prosimy o skonsultowanie się z najbliższym dealerm firmy JVC.

Děkujeme Vám, že jste si zakoupili reproduktory JVC.

Dříve než je začnete používat, přečtěte si prosím pečlivě návod k obsluze, abyste dosáhli co nejlepší možné funkce. Jestliže máte další otázky, spojte se s svým prodejcem JVC.

#### — SAFETY INSTRUCTIONS —

##### “SOME DOS AND DON'TS ON THE SAFE USE OF EQUIPMENT”

This equipment has been designed and manufactured to meet international safety standards but, like any electrical equipment, care must be taken if you are to obtain the best results and safety is to be assured.

Do read the operating instructions before you attempt to use the equipment.

Do ensure that all electrical connections (including the mains plug, extension leads and interconnections between pieces of equipment) are properly made and in accordance with the manufacturer's instructions. Switch off and withdraw the mains plug when making or changing connections.

Do consult your dealer if you are ever in doubt about the installation, operation or safety of your equipment.

Do be careful with glass panels or doors on equipment.

DON'T continue to operate the equipment if you are in any doubt about it working normally, or if it is damaged in any way — switch off, withdraw the mains plug and consult your dealer.

DON'T remove any fixed cover as this may expose dangerous voltages.

DON'T leave equipment switched on when it is unattended unless it is specifically stated that it is designed for unattended operation or has a standby mode.

Switch off using the switch on the equipment and make sure that your family know how to do this.

Special arrangements may need to be made for infirm or handi-capped people.

DON'T use equipment such as personal stereos or radios so that you are distracted from the requirements of traffic safety. It is illegal to watch television whilst driving.

DON'T listen to headphones at high volume as such use can permanently damage your hearing.

DON'T obstruct the ventilation of the equipment, for example with curtains or soft furnishing.

Overheating will cause damage and shorten the life of the equipment.

DON'T use makeshift stands and NEVER fix legs with wood screws — to ensure complete safety always fit the manufacturer's approved stand or legs with the fixings provided according to the instructions.

DON'T allow electrical equipment to be exposed to rain or moisture.

ABOVE ALL

— NEVER let anyone, especially children, push anything into holes, slots or any other opening in the case.

— this could result in a fatal electrical shock;

— NEVER guess or take chances with electrical equipment of any kind

— it is better to be safe than sorry!

<b>Connection</b>	<b>Ansluiting</b>
<b>Anschluß</b>	<b>Liitântä</b>
<b>Raccordement</b>	<b>Tiisluotung</b>
<b>Aansluiting</b>	<b>Csatlakoztatás</b>
<b>Conexión</b>	<b>Połączenia</b>
<b>Collegamento</b>	<b>Zapojení</b>

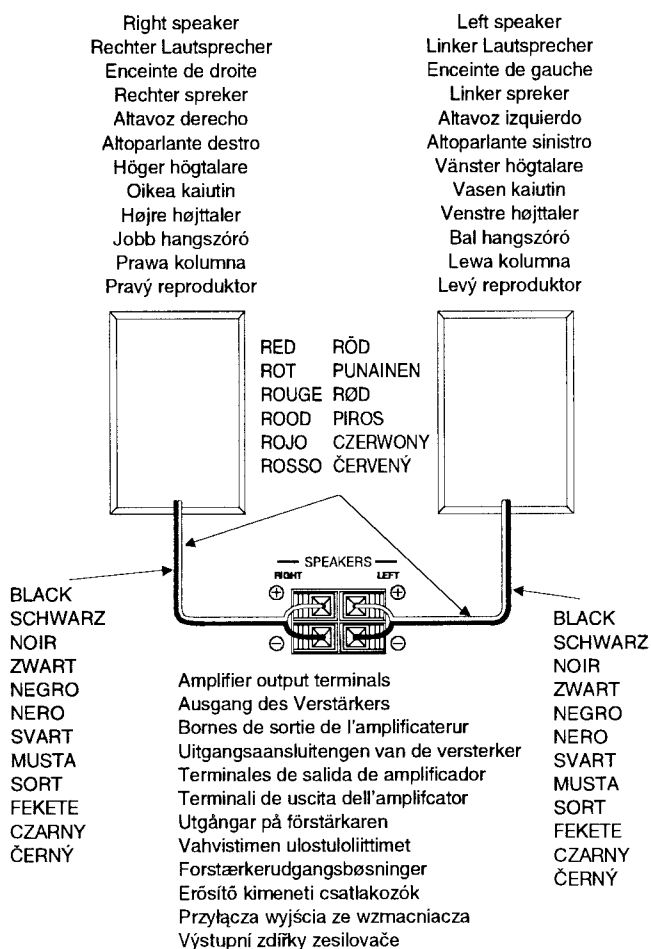

## CONNECTION

- DO NOT use other amplifier to operate this speaker system except for CA-MXK5R.
- Turn off power to the whole system before connecting the speakers to the amplifier.
- The maximum power handling capacity of the SP-MXK5R is 90 W. Excessive input will result in abnormal noise and possible damage. In cases where the signals described below are applied to the speakers, even if the signals are below the maximum allowable input, they may cause an overload and burn the wiring of the speakers. Be sure to lower the amplifier volume beforehand.
  - 1) Noise during FM tuning.
  - 2) High level signals containing high frequency components produced by a tape deck in the fast forward mode.
  - 3) Click noise produced when turning power of other components on and off.
  - 4) Click noise produced when connecting or disconnecting cords with the power on.
  - 5) Click noise produced when the cartridge is replaced with the power on.
  - 6) Click noise produced when operating amplifier switches.
  - 7) Continuous high frequency oscillation or high pitch electronically produced musical instrument sound.
  - 8) Howling when using a microphones.

## SPECIFICATIONS

Type	: 3-way 3-speaker Bass-Reflex Type
Speakers:	
Woofer	: 13.5 cm (5-3/8 in.) cone × 1
Midrange	: 5.0 cm (2 in.) cone × 1
Tweeter	: 2.0 cm (13/16 in.) dome × 1
Power Handling Capacity	: 90 W
Impedance	: 6 Ω
Frequency Range	: 45 Hz — 20 000 Hz
Sound Pressure Level	: 82 dB/W·m
Dimensions (W × H × D)	: 215 mm × 323 mm × 242 mm (8-1/2 in. × 12-3/4 in. × 9-9/16 in.)
Mass	: 3.3 kg (7.3 lbs) each

*Design and specifications subject to change without notice.*



## ANSCHLUSS

- Verwenden Sie zum Betrieb dieses Lautsprechersystems keinen anderen Verstärker, ausgenommen CA-MXK5R.
- Schalten Sie vor dem Anschluß der Lautsprecher an den Verstärker die Spannungsversorgung des gesamten Systems aus.
- Die maximale Belastbarkeit von SP-MXK5R ist 90 W. Eine Überlastung führt zu Verzerrungen und möglicherweise zu Beschädigungen. Signale der unten beschriebenen Art können, auch wenn sie unter dem maximal zulässigen Eingang liegen, eine Überlastung verursachen und die Lautsprecherwicklungen durchbrennen. Verringern Sie vorher die Lautstärke des Verstärkers.
  - 1) Geräusche beim Einstellen von UKW-Sendern.
  - 2) Hochpegelige Signale mit Hochfrequenz-Anteilen, die von Tonbanddecks beim Schnellvorspulen erzeugt werden.
  - 3) Klickgeräusche, wenn die Spannungsversorgung anderer Komponenten ein- und ausgeschaltet wird.
  - 4) Klickgeräusche, wenn Kabel angeschlossen oder abgetrennt werden, während die Spannungsversorgung eingeschaltet ist.
  - 5) Klickgeräusche, wenn der Tonabnehmer des Plattenspielers ausgewechselt wird, während die Spannungsversorgung eingeschaltet ist.
  - 6) Klickgeräusche, die beim Betätigen von Schaltern des Verstärkers erzeugt werden.
  - 7) Ständige Hochfrequenzschwingungen oder elektronisch erzeugte Töne von Musikinstrumenten mit hohen Tönhöhen.
  - 8) Rückkopplungen von Mikrofonen.

## TECHNISCHE DATEN

Typ	: 3-Weg, 3-Lautsprecher-Baßreflexbox
Lautsprecher:	
Tieftöner	: 13,5 cm Konus x 1
Mittbereich	: 5,0 cm Konus x 1
Hochtöner	: 2,0 cm Aufgekelcht x 1
Belastbarkeit	: 90 W
Impedanz	: 6 $\Omega$
Frequenzbereich	: 45 Hz — 20 000 Hz
Schalldruckpegel	: 82 dB/W·m
Abmessungen (B x H x T)	: 215 mm x 323 mm x 242 mm
Gewicht	: Je 3,3 kg

*Technische Änderungen vorbehalten.*

## RACCORDEMENT

- NE PAS utiliser d'autre amplificateur que le CA-MXK5R pour faire fonctionner les enceintes.
- Mettre hors circuit tout le système avant de raccorder les enceintes à l'amplificateur.
- La puissance maximale admissible du SP-MXK5R est de 90 W. En dépassant la puissance admissible, cela provoquera des bruits anormaux et détériorera les enceintes. Au cas où les signaux décrits ci-dessous sont envoyés aux enceintes, et même si ces signaux sont inférieurs à la puissance d'entrée maximum admissible, ils risquent de provoquer une surcharge ou même un incendie. S'assurer de bien diminuer le volume sonore de l'amplificateur.
  - 1) Parasites durant une syntonisation FM.
  - 2) Signaux de niveau élevé contenant des composants à haute fréquence, comme ceux générés par une platine d'enregistrement en mode avance rapide.
  - 3) Cliquetis se produisant lorsque d'autres appareils sont mis en ou hors circuit.
  - 4) Cliquetis se produisant lorsque des appareils sont branchés ou dé-branchés alors que leur alimentation est en circuit.
  - 5) Cliquetis se produisant lorsque la cellule d'une platine tourne-disque est changée alors que l'alimentation est en circuit.
  - 6) Cliquetis se produisant lorsque les commandes de l'amplificateur sont manipulées.
  - 7) Oscillations continues à haute fréquence ou sons très aigus provenant d'instruments de musique électroniques.
  - 8) Hurllements dus à l'utilisation de micros.

## CARACTÉRISTIQUES

Type	: Enceinte 3 voies, 3 haut-parleurs type à réflexion des basses
Haut-parleurs:	
Graves	: conique de 13,5 cm x 1
Médium	: conique de 5,0 cm x 1
Aigus	: dôme de 2,0 cm x 1
Puissance maximale admissible	: 90 W
Impédance	: 6 $\Omega$
Bande passante	: 45 Hz — 20 000 Hz
Pression sonore	: 82 dB/W·m
Dimensions (L x H x P)	: 215 mm x 323 mm x 242 mm
Masse	: 3,3 kg chaque

*Présentation et caractéristiques modifiables sans préavis.*

## AANSLUITINGEN

- Gebruik GEEN andere versterker dan de CA-MXK5R om dit luidsprekersysteem aan te sturen.
- Schakel de spanning van alle aangesloten componenten uit alvorens de luidsprekers met de versterker te verbinden.
- Het maximale vermogen van de SP-MXK5R is 90 W. Te hoge ingang kan in abnormale geluidsreproductie en in beschadigingen resulteren. Overbelasting en verbranding van de bedrading kan worden veroorzaakt, wanneer de hieronder beschreven signalen naar de luidsprekers worden gevoed, zelfs wanneer de signalen onder het maximaal toegestane ingangsvermogen zijn. Verminder eerst het volume van de versterker.
  - 1) Ruis, zoals dit optreedt tijdens afstemming op een FM-zender.
  - 2) Hoogfrequentie signalen van een hoog niveau, zoals die tijdens het vooruitspoelen van een tapedeck worden geproduceerd.
  - 3) Klikkende geluiden, die worden veroorzaakt door het in- en uitschakelen van de netspanning van andere componenten.
  - 4) Klikkende geluiden, zoals die worden geproduceerd bij het tot stand brengen of verbreken van aansluitingen terwijl de netspanning is ingeschakeld.
  - 5) Klikkende geluiden, zoals die optreden bij het vervangen van het element van een draaitafel terwijl de netspanning is ingeschakeld.
  - 6) Klikkende geluiden, zoals die worden geproduceerd door bediening van de schakelaars van de versterker.
  - 7) Voortdurende hoogfrequentie-oscillatie, of hoogtonige, elektronisch geproduceerde geluiden van muziekinstrumenten.
  - 8) Rondzingend geluid bij gebruik van microfoons.

## TECHNISCHE GEGEVENS

Type	: 3-weg 3-luidsprekers bass reflex
Luidsprekers:	
Woofer	: 13,5 cm kegeltipe x 1
Midrange	: 5,0 cm kegeltipe x 1
Tweeter	: 2,0 cm kople x 1
Maximale vermogen	: 90 W
Impedantie	: 6 $\Omega$
Frekwentiebereik	: 45 Hz — 20 000 Hz
Geluidsdruk niveau	: 82 dB/W-m
Afmetingen (B x H x D)	: 215 mm x 323 mm x 242 mm
Gewicht	: Elk 3,3 kg

*Veranderingen in technische gegevens et ontwerp onder voorbehoud.*

## CONEXIÓN

- NO utilice ningún otro amplificador para operar este sistema de altavoces excepto CA-MXK5R.
- Desactive la alimentación de todo el sistema antes de conectar los altavoces al amplificador.
- La capacidad máxima de potencia del SP-MXK5R es de 90 W. Uná entrada excesiva resultará en ruido anormal y posibles daños. En casos donde las señales descritas más abajo se apliquen a los altavoces, aunque las mismas resulten menores que la entrada máxima permisible, pueden causar una sobrecarga y quemar el cableado de los altavoces. Asegúrese de disminuir el volumen del amplificador con anterioridad.
  - 1) Ruido durante la sintonía en FM.
  - 2) Señales de alto nivel que contengan componentes de alta frecuencia producidos por un magnetófono en el modo de avance rápido.
  - 3) Ruidos de conmutación provocados al encender y apagar otros componentes.
  - 4) Ruido de conmutación al conectar o desconectar cables con los componentes encendidos.
  - 5) Ruido de conmutación cuando se reemplaza la cápsula con los componentes encendidos.
  - 6) Ruido de conmutación provocados por la operación de los selectores del amplificador.
  - 7) Continua oscilación de alta frecuencia o de sonidos de tonos altos provocados por instrumentos electrónicos.
  - 8) Aullidos a utilizar micrófonos.

## ESPECIFICACIONES

Tipo	: Reflex bajo con 3-altavoces y 3 vias
Altavoces:	
De graves	: Tipo cónico de 13,5 cm x 1
De Medios	: Tipo cónico de 5,0 cm x 1
De agudos	: Tipo duomo de 2,0 cm x 1
Capacidad de potencia	: 90 W
Impedancia	: 6 $\Omega$
Gama de frecuencias	: 45 Hz — 20 000 Hz
Nivel de presión acústica	: 82 dB/W-m
Dimensiones (An x Al x Prf)	: 215 mm x 323 mm x 242 mm
Peso	: 3,3 kg cada uno

*El diseño y las especificaciones están sujetos a cambio sin aviso.*

## COLLEGAMENTO

- NON usare un amplificatore diverso dal modello CA-MXK5R per utilizzare questo sistema di altoparlanti.
- Spegnete la corrente dell'intero sistema prima di collegare gli altoparlanti all'amplificatore.
- La potenza massima che può essere sopportata è 90 W nel caso del modello SP-MXK5R. Un ingresso eccessivo causerà un suono anormale e possibili danni. Nel caso in cui i segnali descritti qui sotto vengono applicati agli altoparlanti, possono causare un sovraccarico e bruciare il cablaggio degli altoparlanti, anche se i segnali siano al di sotto dell'ingresso massimo ammesso. Assicuratevi di diminuire il livello del volume dell'altoparlante prima di procedere.

- 1) Generazione di rumore durante la sintonizzazione FM.
- 2) Segnali di alto livello che contengono dei componenti ad alta frequenza riprodotti da una piastra a cassette nel modo di avanzamento rapido.
- 3) Si sentirà uno scatto quando accendete o spegnete la corrente degli altri componenti.
- 4) Si sentirà uno scatto quando collegate o scollegate i cavi con la corrente accesa.
- 5) Si sentirà uno scatto quando viene sostituita la cartuccia con la corrente accesa.
- 6) Si sentirà uno scatto quando vengono usati gli interruttori dell'amplificatore.
- 7) Oscillazione continua ad alta frequenza o suoni acuti da strumenti musicali elettronici.
- 8) Ululato quando usate i microfoni.

## SPECIFICAZIONI

Tipo	: Reflex basso con 3-altoparlanti e 3 vie
Altoparlanti:	
Woofer	: Cono da 13,5 cm x 1
Midrange	: Cono da 5,0 cm x 1
Tweeter	: Cupola da 2,0 cm x 1
Capacità di potenza	: 90 W
Impedenza	: 6 $\Omega$
Gamma di frequenza	: 45 Hz — 20 000 Hz
Livello di pressione sonora	: 82 dB/W·m
Dimensioni (L x A x P)	: 215 mm x 323 mm x 242 mm
Massa	: 3,3 kg ciascuno

*Il disegno e le specifiche sono soggetti a cambiamenti senza preavviso.*

## ANSLUTNING

- Använd INTE någon annan förstärkare än CA-MXK5R till att driva detta högtalarsystem med.
- Slå av strömmen i alla apparater i ljudanläggningen innan högtalarna ansluts till förstärkaren.
- Maximal effekthanteringskapacitet för SP-MXK5R är 90 W. Brus uppstår i ljudet och högtalarna kan skadas om de matas med för hög effekt. I situationerna som beskrivs nedan kan högtalarna också överbelastas och kabeltråden inne i högtalarna brännas sönder, fastän högtalarnas effekt inte har överskridits. Sänk därför ljudstyrkan på förhand.
  - 1) Brus under inställning av FM-radiostationer.
  - 2) Starka, högfrekventa signaler från ett kassettdäck under snabbspolning framåt.
  - 3) Ljudbangar som uppstår när andra apparater i anläggningen slås till och från.
  - 4) Skrapljud som uppstår när anslutningskablar ansluts eller kopplas från medan strömmen är på.
  - 5) Skrapljud som uppstår när pickupelementet på en skivspelare byts medan strömmen är på.
  - 6) Ljudbangar som uppstår när du använder förstärkarens omkopplare.
  - 7) Kontinuerliga, högfrekvenssvängningar eller högfrekvent ljud från elektroniska musikinstrument.
  - 8) Akustisk återkoppling (tjutande ljud) vid bruk av mikrofoner.

## TEKNISKA DATA

Typ	: 3-vägs, 3-elements basreflexhögtalare
Högtalarelement:	
Bas	: 13,5 cm kon x 1
Mellanregisten	: 5,0 cm kon x 1
Diskantelement	: 2,0 cm dome x 1
Effekthanteringskapacitet	: 90 W
Impedans	: 6 $\Omega$
Frekvensomfång	: 45 Hz — 20 000 Hz
Ljudtrycksnivå	: 82 dB/W·m
Yttermått (B x H x D)	: 215 mm x 323 mm x 242 mm
Vikt	: 3,3kg perst.

*Rätt till ändringar av utförande och specifikationer förbehålles utan föregående meddelande.*

## LIITÄNTÄ

- ÄLÄ käytä muuta vahvistinta tämän kaiutinjärjestelmän käyttöön paitsi mallille CA-MXK5R.
- Katkaise koko järjestelmän virta ennen kuin suoritat liitännät kaiuttimista vahvistimeen.
- Mallin SP-MXK5R suurin tehonkäsittelykyky on 90 W. Liiallinen antoteho aiheuttaa epänormaalia kohinaa ja jopa vahinkoa. Tapauksissa, missä kaiuttimet joutuvat alla kuvattujen signaalien kohteeksi, vaikka signaalit olisivat alle sallitun maksimi antotehon, ne saattavat aiheuttaa ylikuormitusta ja polttaa kaiuttimien johdot. Vähennä siis vahvistimen äänenvoimakkuutta jo ennalta.
  - 1) Kohinaa FM-virityksen aikana.
  - 2) Kasettidekistä eteenpäinkelauksen aikana muodostuneet vahvat, korkeataajuuksisia komponentteja sisältävät signaalit.
  - 3) Klik-ääni, joka syntyy silloin kun toisten osien virta kytketään ja katkaistaan.
  - 4) Klik-ääni, joka syntyy silloin kun kytketään tai irrotetaan johtoja virran ollessa päällä.
  - 5) Klik-ääni, joka syntyy silloin kun vaihdetaan hylsy virran ollessa päällä.
  - 6) Klik-ääni, joka syntyy silloin kun käytetään vahvistimen kytkimiä.
  - 7) Jatkuva korkea värähtely tai elektronisesti tuotettu korkea soittimen ääni.
  - 8) Ulinaa mikrofonina käytettäessä.

## TILSLUTNING

- Anvend IKKE anden forstærker end CA-MXK5R til drift af dette højttalersystem.
- Sluk for strømmen til hele systemet før højttalerne forbindes til forstærkeren.
- Den maksimale effektbehandlingskapacitet for SP-MXK5R er 90 W. For kraftigt indgangssignal vil resultere i unormal støj og muligvis beskadigelse. I tilfælde hvor højttalerne udsættes for signaler beskrevet nedenfor, kan der forekomme overbelastning og overbrænding af ledningerne i højttalerne selv om signalstyrken er under den maksimale tilladte værdi. Husk derfor at sænke højttalerlydstyrken i forvejen.
  - 1) Støj under FM-afstemning.
  - 2) Signaler med høje niveauer der indeholder højfrekvente komponenter dannet af en båndoptager der er indstillet til hurtig fremspoling.
  - 3) Klikstøj dannet når der tændes eller slukkes for strømmen til andre komponenter.
  - 4) Klikstøj der dannes når ledninger tilsluttes eller tages ud af forbindelse mens der er tændt for strømmen.
  - 5) Klikstøj der dannes når pickuppen udskiftes mens der er tændt for strømmen.
  - 6) Klikstøj der dannes når forstærkerens omskiftere betjenes.
  - 7) Fortsat høj frekvenssvingning, eller en højlyd dannet af et elektronisk instrument.
  - 8) Hyletoner når der anvendes en mikrofon.

## TEKNISET TIEDOT

Tyyppi	: 3-tie, 3 kaiuttimen bassorefleksi
Kaiuttimet:	
Basso	: 13,5 cm karitomuotoinen x 1
Keskikaiutin	: 5,0 cm karitomuotoinen x 1
Diskantti	: 2,0 cm karitomuotoinen x 1
Enimmäisteho	: 90 W
Impedanssi	: 6 Ω
Taajuusala	: 45 Hz — 20 000 Hz
Äänenpainetaso	: 82 dB/W·m
Mitat (L x K x S)	: 215 mm x 323 mm x 242 mm
Paino	: 3,3 kg perst.

*Oikeudet muutoksiin pidätetään.*

## SPECIFIKATIONER

Type	: 3-vejs basrefleks-højttaler med 3-elementer
Højttalere:	
Bashøjttaler	: 13,5 cm membran x 1
Mellemtonehøjttaler	: 5,0 cm membran x 1
Diskantenhed	: 2,0 cm dome x 1
Belastningskapacitet	: 90 W
Impedans	: 6 Ω
Frekvensområde	: 45 Hz — 20 000 Hz
Lydtryksniveau	: 82 dB/W·m
Mål (B x H x D)	: 215 mm x 323 mm x 242 mm
Vægt	: 3,3 kg hver

*Design og specifikationer kan blive ændret uden varsel.*

## CSATLAKOZTATÁS

- A CA-MXK5R erősítőn kívül NE használjon más típusú erősítőt a hangsugárzó rendszerszerhez.
- Mielőtt a rendszert csatlakoztatná az erősítőhöz, kapcsoljon ki minden berendezést.
- Az SP-MXK5R maximális bemenő teljesítménye: fő hangsugárzó - 90W. A maximálisnál nagyobb bemeneti jel abnormális zajjelenséget és a rendszer károsodását okozhatja. Ha az alább leírt karakterisztikájú jelek érik a hangsugárzókat, azok még abban az esetben is túlterhelést és a hangsugárzók tekercselésének károsodását okozhatják, ha teljesítményük az engedélyezett bemeneti szint alatt van. Ezt megelőzően feltétlenül csökkentse az erősítő hangerejét.
  - 1) FM (URH) hangolás alatti zaj.
  - 2) A magnódeck gyors előretekerés során keletkező, magas frekvenciájú komponenseket tartalmazó intenzív jelek.
  - 3) Egyéb berendezés be és kikapcsolásakor keletkező kattánójaj.
  - 4) Bekapcsolt üzemiállapotban a tápkábel össze és szétcsatlakoztatásakor keletkező kattánójaj.
  - 5) Bekapcsolt üzemiállapotban történő patroncsere során keletkező
  - 6) Az erősítő kapcsolóinak használatakor keletkező kattánójaj.
  - 7) Elektromos hangszer által keltett folyamatos, magas frekvenciájú rezgésű vagy magas tónusú hang.
  - 8) Mikrofon használatakor keletkező füttyülő zaj.

## MŰSZAKI ADATOK

Típus	: 3-utas, 3-hangsugárzós, basszreflex típus
Hangsugárzók:	
Mélysugárzó	: 13,5 cm kónuszos x 1
Középsávú	: 5,0 cm kónuszos x 1
Magassugárzó	: 2,0 cm kónuszos x 1
Bemenő teljesítmény	: 90 W
Impedancia	: 6 Ω
Frekvenciatartomány	: 45 Hz — 20 000 Hz
Hangnyomásszint	: 82 dB/W·m
Méret (szélesség x magasság x mélység)	: 215 mm x 323 mm x 242 mm
Tömeg	: 3,3 kg/db

A formaterv és a műszaki adatok változtatásának joga – minden külön értesítés nélkül – fenntartva.

## PODŁĄCZENIE

- NIE podłączać niniejszych kolumn głośnikowych do wzmacniaczy innych niż model CA-MXK5R.
- Przed podłączeniem kolumn do wzmacniacza najpierw wyłączyć sieć całego zestawu.
- Maksymalna moc zestawu SP-MXK5R wynosi: 90 W dla głównego głośnika. Podawanie większego niż dopuszczalny sygnału na wejściu wywoła zakłócenia w emitowanym dźwięku oraz może spowodować uszkodzenie głośników. W przypadku jeżeli na wejściu podane zostaną opisane poniżej sygnały, mogą one spowodować przeciążenie głośników oraz przepalenie przewodów głośników, nawet jeżeli poziom sygnału będzie poniżej maksymalnie dopuszczalnego poziomu. Pamiętać o zmniejszeniu poziomu głośności regulatorem na wzmacniaczu przed użyciem głośników.
  - 1) Szumy w czasie dostrajania pasma FM.
  - 2) Sygnały o wysokim poziomie charakteryzujące się wysokimi częstotliwościami wytworzonymi przez magnetofon kasetowy w czasie przewijania taśmy do przodu.
  - 3) Trzaski pojawiające się w czasie włączania i wyłączenia sieci innych elementów zestawu.
  - 4) Trzaski pojawiające się w czasie podłączania lub odłączania przewodów, kiedy sieć jest włączona.
  - 5) Trzaski pojawiające się w czasie wymiany wkładki gramofonowej, kiedy sieć jest włączona.
  - 6) Trzaski pojawiające się w czasie przełączania włączonego wzmacniacza.
  - 7) Długotrwałe oscylujące wysokie częstotliwości lub inne dźwięki wysokiej częstotliwości elektronicznie syntezowane przez instrument muzyczny.
  - 8) Gwizdy w czasie używania mikrofonu.

## DANE TECHNICZNE

Typ	: 3-drożny 3-głośnikowy Bass-Reflex
Głośniki:	
Niskotonowy	: stożkowy o śr. 13,5 cm x 1
Midrange	: stożkowy o śr. 5,0 cm x 1
Wysokotonowy	: stożkowy o śr. 2,0 cm x 1
Maksymalna moc	: 90 W
Impedancja	: 6 Ω
Zakres częstotliwości	: 45 Hz — 20 000 Hz
Poziom ciśnienia akustycznego	: 82 dB/W·m
Wymiary (Szer. x Wys. x Głęb.)	: 215 mm x 323 mm x 242 mm
Masa	: 3,3 kg jedna sztuka

Wygląd zewnętrzny oraz dane techniczne urządzenia mogą ulec zmianie bez uprzedzenia.

## ZAPOJENÍ

- **NEPOUŽÍVEJTE** jiný zesilovač pro napájení této reproduktorové soustavy než CA-MXK5R.
- Vypojte napájení celé soustavy před zapojením reproduktorů k zesilovači.
- Maximální kapacita zpracování příkonu pro SP-MXK5R: pro hlavní reproduktor je 90 W. Nadměrný vstupní příkon způsobí abnormální zkreslení a možné poškození. V případech, kdy signály popsané níže jsou přivedeny do reproduktorů, a to i tehdy, jestliže jsou signály slabší než maximální povolený vstup, mohou způsobit přetížení a spálení vedení v reproduktorech. Dbejte na snížení hlasitosti zesilovače předem.
  - 1) Šum během FM ladění.
  - 2) Signály vysoké úrovně obsahující vysokofrekvenční komponenty vytvořené magnetofonem při rychlém převijení vpřed.
  - 3) Zvuk lupnutí vytvořený během zapínání a vypínání ostatních komponentů.
  - 4) Zvuk lupnutí vytvořený během zapojování nebo rozpojování šňůr na zapnutém přístroji.
  - 5) Zvuk lupnutí vytvořený při výměně zásobníku na zapnutém přístroji.
  - 6) Zvuk lupnutí vytvořený při obsluze přepínačů zesilovače.
  - 7) Spojitý vysokofrekvenční oscilační nebo vysokotónový zvuk elektronicky vytvořený hudebním nástrojem.
  - 8) Houkání při použití mikrofonů.

## TECHNICKÁ SPECIFIKACE

Typ	: 3-pásmový 3-reproduktorový basreflexový typ
Reproduktory soustavy:	
Hlubkový	: 13,5 cm kuželový x 1
Modrý	: 5,0 cm kuželový x 1
Výškový reproduktor	: 2,0 cm kuželový x 1
Kapacita zpracovatelného příkonu	: 90 W
Impedance	: 6 Ω
Frekvenční rozsah	: 45 Hz — 20 000 Hz
Hladina zvukového tlaku	: 82 dB/W.m
Rozměry (Š x V x H)	: 215 mm x 323 mm x 242 mm
Hmotnost	: 3,3 kg každý

*Vzhled a specifikace podléhají změnám bez předchozího upozornění.*